



L 75480 WD

EN User manual



 **AEG**
perfekt in form und funktion

CONTENTS

1. SAFETY INFORMATION	3
2. SAFETY INSTRUCTIONS	4
3. TECHNICAL INFORMATION	6
4. PRODUCT DESCRIPTION	7
6. CONTROL PANEL	8
7. PROGRAMMES	11
8. CONSUMPTION VALUES	15
9. BEFORE FIRST USE	15
10. USING THE APPLIANCE - WASHING ONLY	15
11. USING THE APPLIANCE - DRYING ONLY	19
12. USING THE APPLIANCE - WASHING & DRYING	20
13. HELPFUL HINTS AND TIPS	22
14. CARE AND CLEANING	24
15. TROUBLESHOOTING	28
16. INSTALLATION	31

FOR PERFECT RESULTS

Thank you for choosing this AEG product. We have created it to give you impeccable performance for many years, with innovative technologies that help make life simpler – features you might not find on ordinary appliances. Please spend a few minutes reading to get the very best from it.

Visit our website for:



Get usage advice, brochures, trouble shooter, service information:
www.aeg.com



Register your product for better service:
www.aeg.com/productregistration



Buy Accessories, Consumables and Original spare parts for your appliance:
www.aeg.com/shop

CUSTOMER CARE AND SERVICE

We recommend the use of original spare parts.
When contacting Service, ensure that you have the following data available.
The information can be found on the rating plate. Model, PNC, Serial Number.



Warning / Caution-Safety information



General information and tips



Environmental information

Subject to change without notice.

1. SAFETY INFORMATION

Before the installation and use of the appliance, carefully read the supplied instructions. The manufacturer is not responsible if an incorrect installation and use causes injuries and damages. Always keep the instructions with the appliance for future reference.

1.1 Children and vulnerable people safety



WARNING!

Risk of suffocation, injury or permanent disability.

- This appliance can be used by children aged from 8 years and above and persons with reduced physical, sensory or mental capabilities or lack of experience and knowledge if they have been given supervision or instruction concerning use of the appliance in a safe way and understand the hazards involved.
- Do not let children play with the appliance.
- Keep all packaging away from children.
- Keep all detergents away from children.
- Keep children and pets away from the appliance door when it is open.
- If the appliance has a child safety device, we recommend you activate it.
- Cleaning and user maintenance shall not be made by children without supervision.

1.2 General Safety

- Before maintenance, deactivate the appliance and disconnect the mains plug from the mains socket.
- Do not change the specification of this appliance.
- Obey the maximum load volume of 8 kg (refer to the "Programme chart" chapter).

- If the supply cord is damaged, it must be replaced by the manufacturer, its service agent or similarly qualified persons in order to avoid a hazard.
- The operating water pressure (minimum and maximum) must be between 0,5 bar (0,05 MPa) and 8 bar (0,8 MPa)
- The ventilation openings in the base (if applicable) must not be obstructed by a carpet.
- The appliance is to be connected to the water mains using the new supplied hose-sets. Old hose sets must not be reused.

2. SAFETY INSTRUCTIONS

2.1 Installation

- Remove all the packaging and the transit bolts.
- Keep the transit bolts. When you move the appliance again you must block the drum.
- Do not install or use a damaged appliance.
- Do not install or use the appliance where the temperature is less than 0 °C or where it is exposed to the weather.
- Obey the installation instruction supplied with the appliance.
- Make sure that the floor where you install the appliance is flat, stable, heat resistant and clean.
- Do not install the appliance where the appliance door can not be fully opened.
- Always be careful when you move the appliance because it is heavy. Always wear safety gloves.
- Make sure that there is air circulation between the appliance and the floor.
- Adjust the feet to have the necessary space between the appliance and the carpet.

Electrical connection



WARNING!

Risk of fire and electrical shock.

- The appliance must be earthed.
- Make sure that the electrical information on the rating plate agrees with the power supply. If not, contact an electrician.
- Always use a correctly installed shock-proof socket.
- Do not use multi-plug adapters and extension cables.
- Make sure not to cause damage to the mains plug and to the mains cable. Should the appliance power supply cable need to be replaced, this must be carried out by our Service Centre.
- Connect the mains plug to the mains socket only at the end of the installation. Make sure that there is access to the mains plug after the installation.
- Do not pull the mains cable to disconnect the appliance. Always pull the mains plug.
- Do not touch the mains cable or the mains plug with wet hands.
- This appliance complies with the E.E.C. Directives.

Water connection

- Make sure not to cause damage to the water hoses.
- The appliance is to be connected to the water mains using the new supplied hose-sets. Old hose sets must not be reused.
- Before you connect the appliance to new pipes or pipes not used for a long time, let the water flow until it is clean.
- The first time you use the appliance, make sure that there is no leakage.

2.2 Use



WARNING!

Risk of injury, electrical shock, fire, burns or damage to the appliance.

- Use this appliance in a household only.
- Do not change the specification of this appliance.
- Do not put flammable products or items that are wet with flammable products in, near or on the appliance.
- Do not touch the glass of the door while a programme operates. The glass can be hot.
- Make sure that you remove all metal objects from the laundry.
- The final part of the drying cycle occurs without heat (cool down cycle) to ensure that the items will not be damaged.

If you stop the appliance before the end of the drying cycle, immediately remove and spread out all items, so that the heat can dissipate.

- If you use detergent, fabric softener or similar products, obey the instructions on the packaging.
- Wipe away lint that has accumulated around the appliance.
- Do not dry the damaged items which contain padding or fillings.
- Do not dry items such as foam rubber (latex foam), shower caps, waterproof textiles and rubber backed articles.
- Before drying items that have been in contact with substances such as cooking oil, acetone, alcohol, petrol, kero-

sene, spot removers, turpentine, waxes and wax removers, wash them in hot water with an extra amount of detergent.

- Do not dry items if industrial chemicals have been used for cleaning.
- Make sure that no gas lighters or matches have been left in the pockets of the clothing.
- Only dry fabrics which are applicable to dry in the tumble dryer. Follow the instructions on the fabric label.
- Do not dry not washed items in the appliance.
- If you have washed your laundry with a stain remover start an extra rinse cycle before you start the appliance.
- Plastic items are not heat resistant.
 - If you use a detergent ball, remove it before you set the drying programme.
 - Do not use a detergent ball when you set a non-stop programme.



WARNING!

Risk of injury or damage to the appliance.

- Do not sit or stand on the open door.
- Obey the maximum load volume.
- Do not dry dripping wet clothes in the appliance.

2.3 Care and Cleaning



WARNING!

Risk of injury or damage to the appliance.

- Before maintenance, deactivate the appliance and disconnect the mains plug from the mains socket.
- Do not use water spray and steam to clean the appliance.
- Clean the appliance with a moist soft cloth. Only use neutral detergents. Do not use abrasive products, abrasive cleaning pads, solvents or metal objects.

2.4 Disposal



WARNING!

Risk of injury or suffocation.

- Disconnect the appliance from the mains supply.
- Cut off the mains cable and discard it.
- Remove the door catch to prevent children and pets to get closed in the appliance.

2.5 Service

- Contact the Service to repair the appliance. We recommend only the use of original spare parts.

3. TECHNICAL INFORMATION

Dimensions	Width / Height / Depth	600 / 850 / 605 mm
	Total depth	640 mm
Electrical connection:	Voltage	230 V
	Overall power	2200 W
	Fuse	10 A
	Frequency	50 Hz
Level of protection against ingress of solid particles and moisture ensured by the protective cover, except where the low voltage equipment has no protection against moisture		IPX4
Water supply pressure	Minimum	0,5 bar (0,05 MPa)
	Maximum	8 bar (0,8 MPa)
Water supply ¹⁾		Cold water
Maximum wash load	Cotton	8 kg
Maximum dry load	Cotton	6 kg
	Synthetics	3 kg
Spin speed	Maximum	1400 rpm

¹⁾ Connect the water inlet hose to a water tap with a 3/4" thread.

4. PRODUCT DESCRIPTION

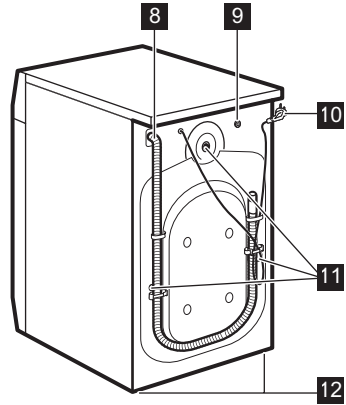
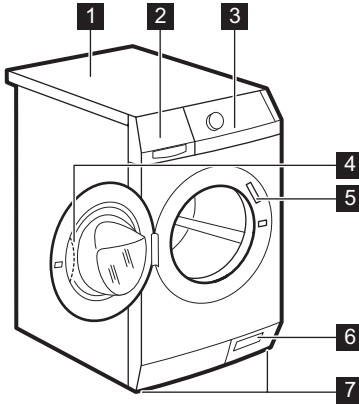

- 1** Worktop
- 2** Detergent dispenser
- 3** Control panel
- 4** Door handle
- 5** Rating plate
- 6** Drain pump
- 7** Feet for the appliance level
- 8** Water drain hose
- 9** Water inlet valve
- 10** Mains cable
- 11** Transit bolts
- 12** Feet for the appliance level

children or pets to be closed in the drum. To activate the device, turn it clockwise, until the groove is horizontal. To deactivate the device, turn it counterclockwise, until the groove is vertical.

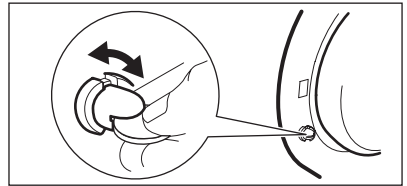

4.1 Child safety device

- When you activate this device, you cannot close the door. This prevents

5. ACCESSORIES

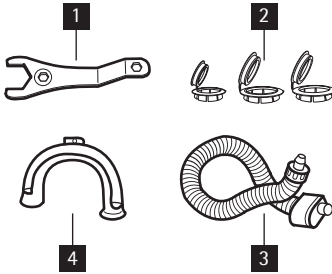

1 Spanner

To remove the transit bolts.

2 Plastic caps

To close the holes on the rear side of the cabinet after the removal of the transit bolts.

3 Anti-flood inlet hose

To prevent possible leakage

4 Plastic hose guide

To connect the drain hose on the edge of a sink.

6. CONTROL PANEL

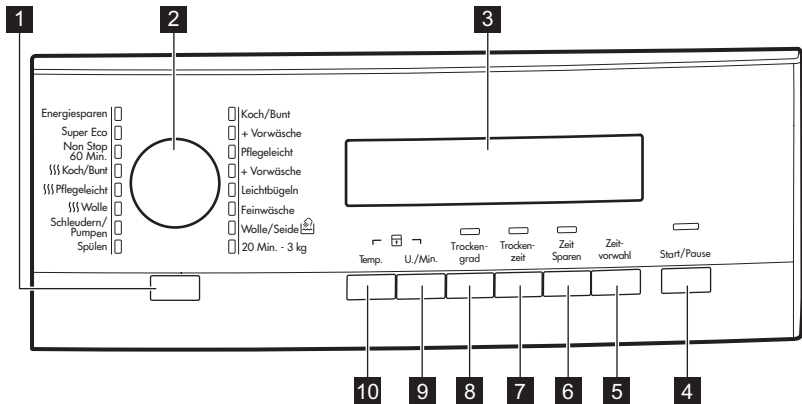

1 On/Off button (**Ein/Aus**)

2 Programme knob

3 Display

4 Start Pause button (**Start/Pause**)

5 Delay start button (**Zeitvorwahl**)

6 Time save button (**Zeit Sparen**)

7 Drying time button (**Trockenzeit**)

8 Automatic drying button (**Trocken-grad**)

9 Spin reduction button (**U./Min.**)

10 Temperature button (**Temp.**)

6.1 On Off button **1**

Press this button to activate or deactivate the appliance. A tune sounds when the appliance is activated.

The AUTO Stand-by function automatically deactivates the appliance to decrease the energy consumption when:

- You do not use the appliance for 5 minutes before you press button **4**.
 - All settings are cancelled.
 - Press button **1** to activate the appliance again.
 - Set again the washing programme and all possible options.

- After 5 minutes from the end of the washing programme. Refer to 'At the end of programme'.







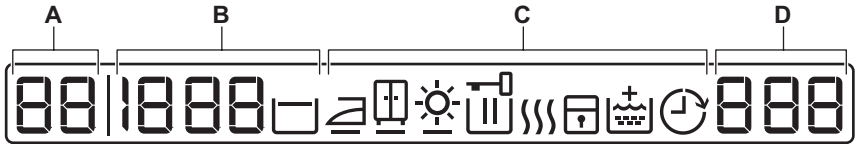



















6.2 Programme knob **2**

Turn this knob to set a programme. The related programme indicator comes on.

6.3 Display **3**



The display shows:

A	<ul style="list-style-type: none"> • The maximum temperature of the programme. 																		
B	<ul style="list-style-type: none"> • The default spin speed of the programme. • 'No Spin'¹⁾ and 'Rinse Hold' symbols. 																		
C	<p>Dryness levels symbols:²⁾</p> <table border="1"> <tbody> <tr> <td></td> <td>Iron dry</td> </tr> <tr> <td></td> <td>Store dry</td> </tr> <tr> <td></td> <td>Extra dry</td> </tr> </tbody> </table> <p>The display symbols:³⁾</p> <table border="1"> <tbody> <tr> <td></td> <td>Washing phase</td> </tr> <tr> <td></td> <td>Drying phase</td> </tr> <tr> <td></td> <td>Extra rinse</td> </tr> <tr> <td></td> <td>Child lock</td> </tr> <tr> <td></td> <td> <p>You cannot open the appliance door when the symbol is on. You can open the door only when the symbol goes off.</p> <p>If the programme is completed but the symbol stays on:</p> <ul style="list-style-type: none"> • There is water in the drum. • The 'Rinse Hold' function is on. </td> </tr> <tr> <td></td> <td>Delay start</td> </tr> </tbody> </table>		Iron dry		Store dry		Extra dry		Washing phase		Drying phase		Extra rinse		Child lock		<p>You cannot open the appliance door when the symbol is on. You can open the door only when the symbol goes off.</p> <p>If the programme is completed but the symbol stays on:</p> <ul style="list-style-type: none"> • There is water in the drum. • The 'Rinse Hold' function is on. 		Delay start
	Iron dry																		
	Store dry																		
	Extra dry																		
	Washing phase																		
	Drying phase																		
	Extra rinse																		
	Child lock																		
	<p>You cannot open the appliance door when the symbol is on. You can open the door only when the symbol goes off.</p> <p>If the programme is completed but the symbol stays on:</p> <ul style="list-style-type: none"> • There is water in the drum. • The 'Rinse Hold' function is on. 																		
	Delay start																		

- D**
- The programme time (washing and/or drying phase)
When the programme starts, the time decreases with steps of 1 minute.
 - The delay start
When you press the delay start button, the display shows the delay start time.
 - Alarm codes
If the appliance has a malfunction, the display shows alarm codes. Refer to 'Troubleshooting' chapter.
 - Err
The display shows this message for some seconds if:
 - You set a function that is not applicable for the programme.
 - You change the programme while it operates.
 The indicator of the Start/Pause button **4** flashes.
 - 
When the programme is completed.

1) Only available for Spin/Drain programme

2) They come on when you set an automatic drying programme.

3) The symbols appear on the display when the related phase or function is set.

6.4 Start/Pause button **4**

Press button **4** to start or interrupt a programme.

6.5 Delay start button **5**

Press button **5** to delay the start of a programme from 30 minutes to 20 hours.

6.6 Time save button **6**

Press the button **6** to decrease the programme duration.

- Press one time to set 'Shortened duration' for items with daily soil.
- Press two times to set 'Extra Quick' for items with almost no soil.

 Some programmes accept only one of the two functions.

6.7 Drying time button **7**

Press this button to set the time that suits the fabrics you have to dry. The display shows the set value. Each time you press this button the time value increases by 5 minutes.



You cannot set all time values for different types of fabrics.

6.8 Automatic dry button **8**

Press this button to set an automatic level of dryness for the laundry. The display shows the symbol of the set level.

- Extra dry
- Cupboard dry
- Iron dry



You can not set all automatic levels for each type of fabrics.

6.9 Permanent extra rinse function

With this function you can keep the extra rinse function permanently on when you set a new programme.

- To activate the function press button **6** and button **5** at the same time until the indicator of button **7** is on.
- To deactivate the function press button **6** and button **5** at the same time until the indicator of button **7** is off.

6.10 Spin button



Press this button to:

- Decrease the maximum speed of the spin phase when you set a programme.





The display shows only the spin speeds available with the set programme.

- Deactivate the spin phase.
- Activate the 'Rinse Hold' function. Set this function to prevent fabric creases. The appliance does not drain the water when the programme is completed.

	Spin phase is off.
	'Rinse Hold' function is on.

6.11 Temperature button



Press button  to change the default temperature.

	= cold water
---	--------------

6.12 Acoustic signals function

You can hear the acoustic signals when:

- You activate the appliance.
- You deactivate the appliance.
- You press the buttons.
- The programme is completed.
- The appliance has a malfunction.









To **deactivate/activate** the acoustic signals, press button  and button  at the same time for 6 seconds.



If you deactivate the acoustic signals, they continue operate only when you press the buttons and when a malfunction occurs.

6.13 Child lock function

This function prevents children to play with the control panel.

- To activate the function, press button  and button  at the same time until the display shows the symbol .
- To deactivate the function, press button  and button  at the same time until the symbol  goes off. You can activate the function:
 - Before you press the Start/Pause button : the appliance cannot start.
 - After you press the Start/Pause button , all the buttons and the programme knob are deactivated.

7. PROGRAMMES

Programme Temperature	Type of load max. weight of load	Cycle description	Functions
WASHING PROGRAMMES			
Koch/Bunt 95° - Cold	White and coloured cotton with normal soil. max. 8 kg	Wash Rinses Long spin	SPIN REDUCTION RINSE HOLD EXTRA RINSE TIME SAVE ¹⁾
Koch/Bunt + Vorwäsche 95° - Cold	White and coloured cotton with heavy soil. max. 8 kg	Prewash Wash Rinses Long spin	SPIN REDUCTION RINSE HOLD EXTRA RINSE TIME SAVE ¹⁾

Programme Temperature	Type of load max. weight of load	Cycle description	Functions
Pflegeleicht 60° - Cold	Synthetic or mixed fabric items with normal level of soil. max. 4 kg	Wash Rinses Short spin	SPIN REDUCTION RINSE HOLD EXTRA RINSE TIME SAVE ¹⁾
Pflegeleicht + Vorwäsche 60° - Cold	Synthetic or mixed fabric items with heavy soil. max. 4 kg	Prewash Wash Rinses Short spin	SPIN REDUCTION RINSE HOLD EXTRA RINSE TIME SAVE ¹⁾
Leichtbügeln 2) 60° - Cold	Synthetic fabric items with normal soil. The wash and spin phase is soft to prevent the creases of the laundry. The appliance adds some rinses. max. 4 kg	Wash Rinses Short spin	SPIN REDUCTION RINSE HOLD EXTRA RINSE TIME SAVE ¹⁾
Feinwäsche 40° - Cold	Delicate fabrics as acrylics, viscose, polyester items with normal soil. max. 4 kg	Wash Rinses Short spin	SPIN REDUCTION RINSE HOLD EXTRA RINSE TIME SAVE ¹⁾
Wolle / Seide  40° - Cold	Machine washable wool. Hand washable wool and delicate fabrics with «hand washing» care symbol. max. 2 kg	Wash Rinses Short spin	SPIN REDUCTION RINSE HOLD
20 Min. - 3 kg 40° - 30°	Quick wash of sport items or cotton and synthetic items, lightly soiled or worn once. max. load 3 kg	Wash Rinses Short spin	SPIN REDUCTION
Spülen	All fabrics.	One rinse with additive spin phase	SPIN REDUCTION RINSE HOLD EXTRA RINSE ³⁾
Schleudern / Pumpen 4)	All fabrics The maximum load of the laundry is related to the type of laundry.	Drainage of the water Spin phase at the maximum speed.	SPIN REDUCTION NO SPIN

Programme Temperature	Type of load max. weight of load	Cycle description	Functions
DRYING PROGRAMMES			
Wolle)))	Wool items max. 1 kg	Timed drying only	
Pflegeleicht)))	Synthetic items max. 3 kg	Automatic drying or timed drying	
Koch/Bunt)))	Cotton items max. 6 kg	Automatic drying or timed drying	
Non Stop 60 Min. 40°	Complete programme composed of washing phase + drying phase for a small load size of mixed fabrics (cotton and synthetic items). max. 1 kg	Wash Rinses Short spin Automatic drying	
WASHING PROGRAMMES			
Super Eco ⁵⁾ Cold	Mixed fabrics (cotton and synthetic items). max. 3 kg	Wash Rinses Short spin	SPIN REDUCTION RINSE HOLD EXTRA RINSE
Energiesparen 6) 60° - 40°	White and fast coloured cotton with normal soil. For cotton economy programmes you can set only the Extra Quick duration. max. 8 kg	Wash Rinses Long spin	SPIN REDUCTION RINSE HOLD EXTRA RINSE TIME SAVE ¹⁾

- 1) if you press the button 6 two times (Extra Quick duration), we recommend that you decrease the quantity of the load. It is possible to load fully the appliance, however the washing results are reduced.
- 2) This programme it is not compatible with drying.
- 3) Press EXTRA RINSE button to add rinses. With a low spin speed the appliance performs delicate rinses and a short spin.
- 4) The default phase of the spin speed is related to cotton items. Set the spin speed. Make sure that it agrees with the laundry. To select the DRAIN programme only, set the function NO SPIN.
- 5) Set this programme to decrease the time and the consumption of energy and water.
- 6) Cotton Energy Saving programme » at 60°C with a load of 8 kg is the reference programme for the data entered in the energy label, in compliance with EEC 92/75 standards.

7.1 Programmes for automatic drying

Level of dryness	Type of fabric	Load
Extra dry For towelling materials	Cotton and linen (bathrobes, bath towels, etc.)	up to 6 kg
Store dry For items to put away	Cotton and linen (bathrobes, bath towels, etc.)	up to 6 kg
	Synthetics and mixed fabrics (jumpers, blouses, underwear, household linen)	up to 3 kg
Iron dry For ironing	Cotton and linen (sheets, tablecloths, shirts, etc.)	up to 6 kg

7.2 Programmes for timed drying

Degree of drying	Type of fabric	Load (Kg)	Spin speed (rpm)	Suggested times (mins)
Extra dry For towelling materials	Cotton and linen (bathrobes, bath towels, etc.)	6	1400	225 - 245
		4	1400	135 - 155
		2	1400	95 - 105
Cupboard dry¹⁾ For items to put away	Cotton and linen (bathrobes, bath towels, etc.)	6	1400	215 - 235
		4	1400	125 - 145
		2	1400	85 - 95
Cupboard dry For items to put away	Synthetics and mixed fabrics (jumpers, blouses, underwear, household linen)	3	1200	135 - 145
		1	1200	40 - 50
Iron dry Suitable for ironing	Cotton and linen (sheets, tablecloths, shirts, etc.)	6	1400	185 - 205
		4	1400	95 - 115
		2	1400	75 - 85
Wool dry	Wool (jumpers)	1	1200	110 - 130

1) Hints for test institute

The test performance, in accordance with EN 50229, must be carried out with the a FIRST drying load of 5 kg (load composition : pillowcase and towels) by setting the AUTOMATIC CUPBOARD DRY programme for Cotton.

The SECOND drying load of 3 kg (load composition: 3 sheets and towels) must be tested by setting the AUTOMATIC CUPBOARD DRY programme for Cotton.

8. CONSUMPTION VALUES

Programme	Energy consumption (KWh)	Water consumption (litres)	Programme duration (minutes)
White Cottons 95°	2.5	76	For the duration of the programmes, please refer to the display on the control panel.
Cottons 60°	1.60	72	
Cotton Energy Saving Programme 60° ¹⁾	1.04	59	
Cottons 40°	1.0	72	
Synthetics 40°	0.60	50	
Delicates 40°	0.70	60	
Wool/ Handwash 30°	0.35	57	

1) «Cotton Energy Saving programme » at 60°C with a load of 8 kg is the reference programme for the data entered in the energy label, in compliance with EEC 92/75 standards.



The consumption data shown on this chart is to be considered purely indicative, as it may vary depending on the quantity and type of laundry, on the inlet water temperature and on the ambient temperature.

9. BEFORE FIRST USE

1. To activate the drain system, put 2 litre of water in the main wash compartment of the detergent dispenser.
2. Put a small quantity of detergent in the main wash compartment of the

detergent dispenser. Set and start a programme for cotton at the highest temperature without laundry. This removes all possible dirt from the drum and the tub.

10. USING THE APPLIANCE - WASHING ONLY

1. Open the water tap.
2. Connect the mains plug to the mains socket.
3. Press button **1** to activate the appliance.
4. Put the laundry in the appliance.
5. Use the correct quantity of detergent and additives.

6. Set and start the correct programme for the type of laundry and soil.

10.1 Loading the laundry

1. Open the appliance door.
2. Put the laundry in the drum, one item at a time. Shake the items before you put them in the appliance.

Make sure not to put too much laundry in the drum.



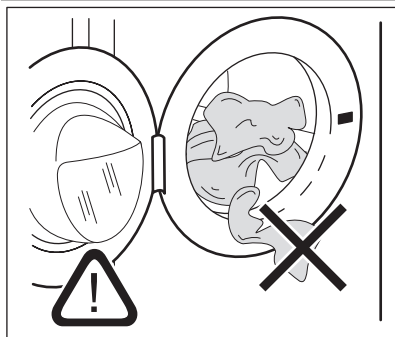

3. Close the door.

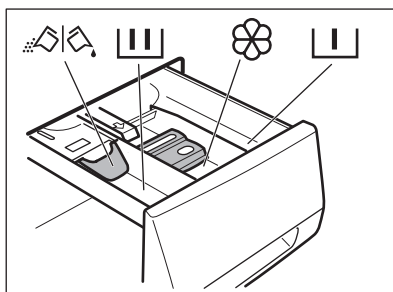

Make sure that no laundry stays between the seal and the door. There is a risk of water leakage or damage to the laundry.

10.2 Filling the detergent and additives



	The detergent compartment for the prewash phase, the soak programme and for the stain function. Add the detergent for prewash, soak and stain remover before the start of the programme.
	The detergent compartment for the washing phase. If you use a liquid detergent, put it immediately before you start the programme.
	Liquid additives compartment (fabric conditioner, starch). Put the product in the compartment before you start the programme.
MAX	This is the maximum level for the quantity of liquid additives.
	Flap for powder or liquid detergent Turn it (up or down) in the correct position to use powder or liquid detergent.
	Always obey the instructions that you find on the packaging of the detergent products.

Check the position of the flap

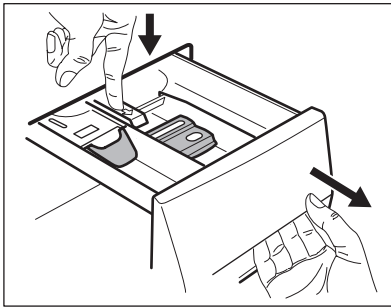

1. Pull out the detergent dispenser until it stops.
2. Press the lever down to remove the dispenser.

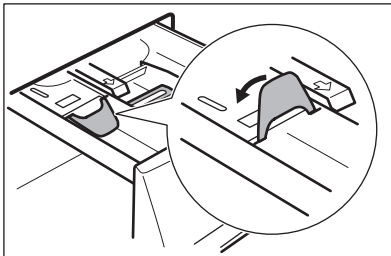

3. To use powder detergent, turn the flap up.

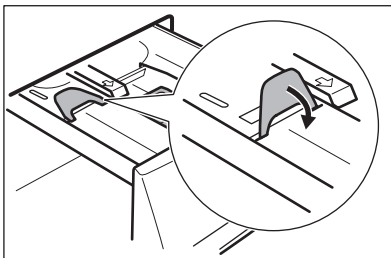

4. To use liquid detergent, turn the flap down.



With the flap in the position DOWN:

- Do not use gelatinous or thick liquid detergents.
- Do not put more liquid detergent than the limit showed in the flap.
- Do not set the prewash phase.
- Do not set the delay start function.

5. Measure out the detergent and the fabric conditioner.
6. Carefully close the detergent dispenser. Make sure that the flap does not cause a blockage when you close the drawer.

10.3 Setting and starting a programme

1. Turn the programme knob. The related programme indicator comes on.
2. The indicator of button **4** flashes with red colour.
3. The display shows the default temperature and spin speed. To change the temperature and/or the spin speed, press the related buttons.
4. Set the available functions. The indicator of the set function comes on or the display shows the related symbol.

- Press button **4** to start the programme. The indicator of button **4** is on.



The drain pump can operate for a short time when the appliance fills water.



The appliance adjust automatically the cycle time to the laundry you have put in the drum to have perfect washing results in the minimum necessary time. After approximately 15 minutes from the start of the programme, the display shows the new time value.

10.4 Interrupt a programme

- Press button **4**. The indicator flashes.
- Press button **4** again. The washing programme continues.

10.5 Cancel a programme

- Press button **1** to cancel the programme and to deactivate the appliance.
- Press button **1** again to activate the appliance. Now, you can set a new washing programme.



The appliance does not drain the water.

10.6 Change a function

You can change only some functions before they operate.

- Press button **4**. The indicator flashes.
- Change the function set.

10.7 Set the delay start

- Press button **5** again and again until the display shows the number of minutes or hours. The related symbols comes on.
- Press button **4**, the appliance starts the countdown of the delay start.

When the countdown is completed, the programme starts automatically.



Before you press button **4** to start the appliance, you can cancel or change the set of the delay start.

You cannot set the delay start with the **Steam** programme.

10.8 Cancel the delay start

- Press button **4**. The related indicator flashes.
- Press button **5** again and again until the display shows **0'**.
- Press button **4**. The programme starts.

10.9 Open the door

While a programme or the delay start operates, the appliance door is locked.

To open the appliance door:

- Press button **4**. The door lock symbol in the display goes off.
- Open the appliance door.
- Close the appliance door and press button **4**. The programme or the delay start continues.



If the temperature and level of the water in the drum are too high, the door lock symbol stays on and you cannot open the door. To open the door do the steps that follow:

- Deactivate the appliance.
- Wait for some minutes.
- Make sure that no water is in the drum.



If you deactivate the appliance, it is necessary to set the programme again.

10.10 At the end of the programme

- The appliance stops automatically.
- The acoustic signals operate.
- In the display **0** comes on.
- The indicator of the Start/Pause button **4** goes off.

- The door lock symbol goes off.
- Press button **1** to deactivate the appliance. After five minutes from the end of the programme, the energy saving function automatically deactivates the appliance.

 When you activate the appliance again, the display show the end of the last set programme. Turn the programme knob to set a new cycle.

- Remove the laundry from the appliance. Make sure that the drum is empty.
- Keep the door ajar, to prevent mildew and odours.
- Close the water tap.

The washing programme is completed, but there is water in the drum:

- The drum turns regularly to prevent the creases in the laundry.

- The door stays locked.
- You must drain the water to open the door.

To drain the water:

1. If necessary, decrease the spin speed.
2. Press the Start/Pause button **4**. The appliance drain the water and spin.
3. When the programme is completed and the door lock symbol goes off, you can open the door
4. Deactivate the appliance.

 The appliance drain and spin automatically after approximately 18 hours.

11. USING THE APPLIANCE - DRYING ONLY



WARNING!

Open the water tap. Put the drain hose in the sink or connect to the drain pipe.

- Load the laundry.
- Turn the programme dial to the programme suitable for the items to dry.

 The drying symbol comes on.

 To have best performances in drying when you wash the laundry set a spin cycle at the maximum speed allowed for your type of items.

You can dry your laundry in two ways:

With the **automatic drying**:

- press the button **8** again and again until a black line appears under one of the dryness level symbol:

 Extra dry symbol



Cupboard dry symbol



Iron dry symbol

- The display shows a time value, calculated on a default load size. If the amount of your laundry is more or less than the default size, the appliance adjusts automatically the time value during the cycle.
- Press the button **4** to start the programme.



The door locked symbol comes on.



The drying symbol starts to flash.



You cannot set all levels for all type of laundry.

With the **timed drying**:

- Press the button **7** again and again to set the drying time value (see the «Programme for timed drying» table).

The display shows a minimum time value.

40 Set time value

- Each time you press this button the time value increases by 5 minutes.
- After some seconds the time value on the display changes: the appliance calculates also the duration of the anti-crease and the cooling phases.

43 Final time value

- Press button **4** to start the programme. The display shows the new time value every minute.

 The drying symbol starts to flash.

 The door locked symbol comes on.

-  If you set the time value of only 10 minutes, the appliance performs only a cooling phase.

At the end of the programme

- The appliance stops automatically.

- The acoustic signals operate.
- In the display  comes on.
- The indicator of the Start/Pause button **4** goes off.

-  The last minutes of the drying cycle the appliance performs the anti-crease and the cooling phases.

- Press button **1** to deactivate the appliance. After some minutes from the end of the programme, the energy saving function automatically deactivates the appliance.
- When the door locked symbol  goes off, you can open the door.
- Remove the laundry from the appliance. Make sure that the drum is empty.
- Keep the door ajar, to prevent mildew and odours.
- Close the water tap.

12. USING THE APPLIANCE - WASHING & DRYING

12.1 NON-STOP programme - Washing & Automatic drying



CAUTION!
Do not put a plastic device/ball for the detergent into the drum.





- Press button **1** to activate the appliance.
- Load the laundry.
- Measure out the detergent and fabric conditioner.
- Turn the programme dial to the washing programme. The display shows the wash symbols.



CAUTION!
Do not set a spin speed lower than the automatic speed of the set programme.

- Set the available options.

- Press the button **7** until the black line appears under one of the dryness level symbol.

	The iron dry level comes on.
	The cupboard dry level comes on.
	The extra dry level comes on.
	The drying symbol comes on.

The time value on the display is the duration of the washing + drying cycles calculated on a default load size.

- Press button **4** to start the programme.



The set dryness level symbol stays on. The others level symbols go off.



The door locked symbol comes on.

The display shows the new time value each minute.



The last minutes of the drying cycle the appliance performs the anti-crease and the cooling phases.

- When the programme is completed, the appliance stops automatically.
- The acoustic signals operate.
- When the symbol  goes off, you can open the door.
- Remove the laundry from the appliance. Make sure that the drum is empty.
- Close the water tap.
- Keep the door ajar, to prevent mildew and odours.

12.2 NON-STOP programme - Washing & Timed Drying



CAUTION!

Do not put a plastic device/ball for the detergent into the drum.

- Press button **1** to activate the appliance.
- Load the laundry.
- Measure out the detergent and the fabric conditioner.
- Turn the programme dial to the washing programme. The display shows the wash symbols.

Do not set a spin speed lower than the automatic speed of the set programme.

- Set the available options.
- Press the button **7** to set the drying time value. The display shows a minimum time value.



The drying symbol comes on.



Set drying time value

- After some seconds the display shows the total duration of the cycles.



Final time value (washing + drying + anti-crease + cooling phases)



If you set a drying time of only 10 minutes, the final time value includes also the anti-crease and the cooling phases.

- Press button **4** to start the programme.



The door is locked

The display shows the new time value each minute.

- When the programme is completed, the appliance stops automatically.
- The acoustic signals operate.
- When the door locked symbol  goes off, you can open the door.
- Remove the laundry from the appliance. Make sure that the drum is empty.
- Close the water tap.
- Keep the door ajar, to prevent mildew and odours.

12.3 Fluff in the fabrics

During the washing and/or drying phase, some types of fabric, (sponge, wool, sweatshirt) could release fluff.

The released fluff could stick to the fabrics during the next cycle.

This inconvenient increases with technical fabrics.

To prevent the fluff in your laundry, we recommend that you:

- To do not wash dark fabrics after you washed and dried light coloured fabrics (new sponge, wool, sweatshirt) and the contrary.
- To dry this type of fabrics at open air when they are washed the first time.
- To clean the drain filter.
- After the drying phase, clean the empty drum, the gasket and the door with a wet cloth.

To remove the fluff inside the drum, set a special programme:

- Empty the drum.
- Clean the drum, the gasket and the door with a wet cloth.
- Set the rinse programme.

- Press at the same time button **9** and button **7** to activate the cleaning function until the display shows **CLE**.
- Press button **4** to start the programme.

13. HELPFUL HINTS AND TIPS

13.1 The laundry load

- Divide the laundry in: white, coloured, synthetics, delicates and wool.
- Obey the washing instructions that are on the laundry care labels.
- Do not wash together white and coloured items.
- Some coloured items can discolour with the first wash. We recommend that you wash them separately for the first times.
- Button up pillowcases, close zippers, hooks and poppers. Tie up belts.
- Empty the pockets and unfold the items.
- Turn inside out multilayered fabrics, wool and items with painted illustrations.
- Remove hard stains.
- Wash with a special detergent heavy soil stains.
- Be careful with the curtains. Remove the hooks or put the curtains in a washing bag or pillowcase.
- Do not wash in the appliance :
 - Laundry without hems or with cuts
 - Underwired bras.
 - Use a washing bag to wash small items.
- A very small load can cause balance problems with the spin phase. If this occurs, adjust manually the items in the tub and start the spin phase again.

13.2 Stubborn stains

For some stains, water and detergent is not sufficient.

We recommend that you remove these stains before you put the items in the appliance.

Special stain removers are available. Use the special stain remover that is applicable to the type of stain and fabric.

13.3 Detergents and additives

- Only use detergents and additives specially made for washing machines.
- Do not mix different types of detergents.
- To help the environment, do not use more than the correct quantity of detergent.
- Obey the instructions that you find on the on packaging of these products.
- Use the correct products for the type and colour of the fabric, the programme temperature and the level of soil.
- If you use liquid detergents, do not set the prewash phase.
- If your appliance has not the detergent dispenser with the flap device, add the liquid detergents with a dosing ball.

13.4 Water hardness

If the water hardness in your area is high or moderate, we recommend that you use a water softener for washing machines. In areas where the water hardness is soft it is not necessary to use a water softener.

To know the water hardness in your area, contact your local water authority.

Obey the instructions that you find on the packaging of the products.

Equivalent scales measure the water hardness:

- German degrees (°dH).
- French degrees (°TH).

- mmol/l (millimol for each litre - international unit for the hardness of water).
- Clarke degrees.

Water hardness table

Level	Type	Water hardness			
		°dH	°T.H.	mmol/l	Clarke
1	soft	0-7	0-15	0-1.5	0-9
2	medium	8-14	16-25	1.6-2.5	10-16
3	hard	15-21	26-37	2.6-3.7	17-25
4	very hard	> 21	> 37	>3.7	>25

13.5 Drying hints

Prepare the drying cycle



- Open the water tap.
- Do a check if the connection of the drain hose is correct. Refer to installation chapter for more information.
- For the maximum laundry load of the drying programmes, refer to the drying programmes table.



Do not set a drying programme for this laundry:

- Very delicate items.
- Synthetic curtains.
- Woollen and silk items.
- Pieces of clothing with metal inserts.
- Nylon stockings.
- Quilts.
- Bed covers.
- Duvets.
- Anoraks.
- Sleeping bags
- Fabrics with residue of hair sprays, nail solvents or similar.
- Garments with foam-rubber or materials similar to foam-rubber.

13.6 Garment labels

When you dry ther laundry, obey the indications on the labels of the manufacturers:

-  = The item can be tumble dried
-  = The drying cycle is at high temperature

-  = The drying cycle is at reduced temperature
-  = The item can not be tumble dried.

13.7 Drying cycle duration

The drying time can change depending on:

- speed of the last spin
- dryness level
- type of laundry
- weight of the load size

GENERAL TIPS

Refer to the «Drying programmes» table to find the **average** drying times.

The experience will help you to dry the laundry in a more correct way. Take note of the duration drying time of the cycles done before.

To avoid the static charge at the end of the drying cycle:

- Use fabric conditioner in the washing cycle.
- Use special fabric conditioner for tumble dryers.

When the drying programme is completed remove the laundry in a short time.

13.8 Additional drying

If, at the end of the drying programme, the laundry is still damp, set a short drying cycle again.



WARNING!

To avoid creases of fabrics or shrinks of the clothing do not over dry the laundry.

14. CARE AND CLEANING



WARNING!

Disconnect the appliance from the mains supply before you clean it.

14.1 Descaling

The water we use contains limescale. If it becomes necessary, use a water softener to remove limescales.

Use a special product made for washing machines. Obey the instructions that you find on the packaging of the manufacturer.

Do this separately from the laundry wash.

14.2 External cleaning

Clean the appliance only with soap and warm water. Fully dry all the surfaces.

14.4 Door seal



CAUTION!

Do not use alcohol, solvents or chemical products.

14.3 Maintenance wash

With the low temperature programmes it is possible that some detergent stays in the drum. Make regularly a maintenance wash. To do this:

- Empty the laundry from the drum.
- Set the hottest cotton wash programme
- Use a correct quantity of powder detergent with biological properties.

After each wash, keep the door open for a while to prevent mould and to let unpleasant smells go out.

Regularly examine the seal and remove all objects from the inner part.

14.5 Drum

Regularly examine the drum to prevent limescale and rust particles.

Only use special products to remove rust particles from the drum.

To do this:

- Clean the drum with special product for stainless steel.
- Start a short programme for cotton at the maximum temperature with a small quantity of detergent.

14.6 Detergent dispenser

To clean the dispenser:

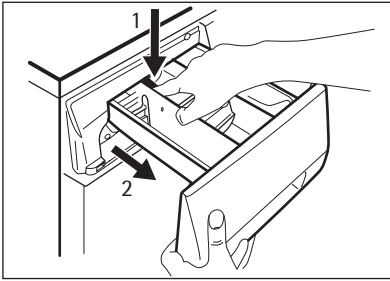

1. Press the lever.
2. Pull the dispenser out.

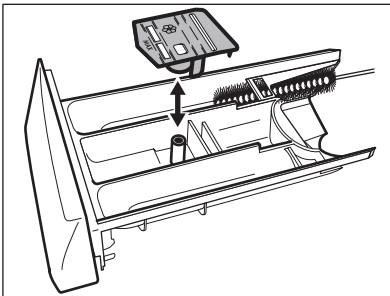

3. Remove the top part of the liquid additive compartment.
4. Clean all the parts with water.

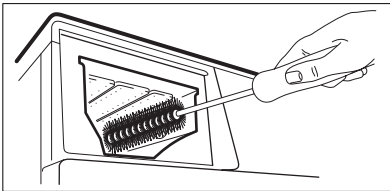

5. Clean the dispenser recess with a brush.
6. Put back the dispenser in the recess.

14.7 Drain pump



Regularly examine the drain pump and make sure that it is clean.

Clean the pump if:

- The appliance does not drain the water.
- The drum cannot turn.
- The appliance makes an unusual noise because of the blockage of the drain pump.

- The display shows an alarm code because of the problem with water drain.



WARNING!

1. Disconnect the mains plug from the mains socket.
2. Do not remove the filter while the appliance operates. Do not clean the drain pump if the water in the appliance is hot. The water must be cold before you clean the drain pump.

To clean the drain pump:

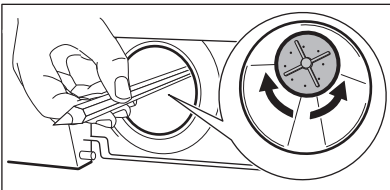
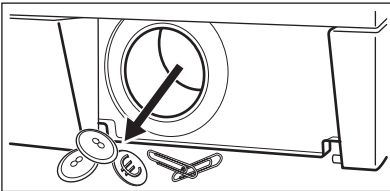
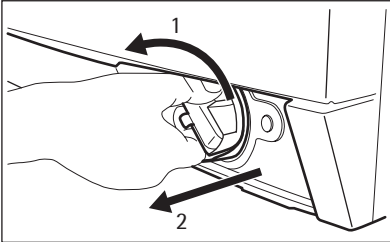
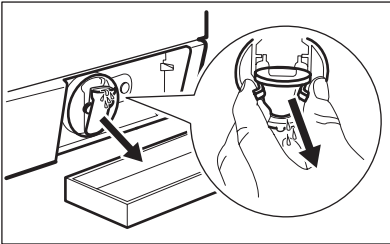
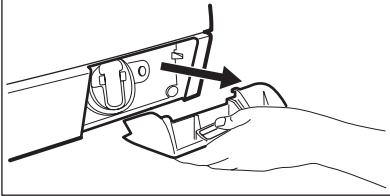
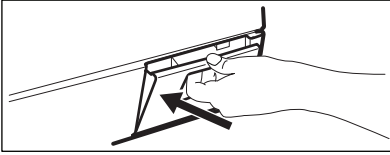

1. Open the drain pump door.
2. Pull the flap out to remove it.
3. Put a container below the recess of the drain pump to collect the water that flows out.
4. Press the two levers and pull forward the drainage duct to let the water flow out.
5. When the container is full of water, put the drainage duct back again and empty the container. Do steps 4 and 5 again and again until no more water flows out from the drain pump.
6. Pull back the drainage duct and turn the filter to remove it.
7. Remove fluff and objects from the pump.
8. Make sure that the impeller of the pump can turn. If this does not occur, contact the service centre.

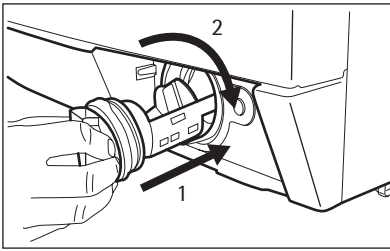

14.8 The inlet hose filter and the valve filter

It could be necessary to clean the filters when:

- The appliance does not fill with water.
- The appliance fills with the water for a long time.

9. Clean the filter under the water tap and put it back in the pump into the special guides.
10. Make sure that you tighten correctly the filter to prevent leakages.
11. Put the flap back and close the drain pump door.

- The indicator of button **4** flashes and the display shows the related alarm. Refer to 'Troubleshooting'.



WARNING!

Disconnect the mains plug from the mains socket.

To clean the water inlet filters:

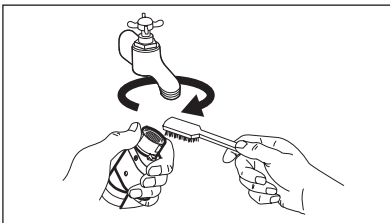

1. Close the water tap.
2. Remove the water inlet hose from the water tap.
3. Clean the filter in the inlet hose with a stiff brush.

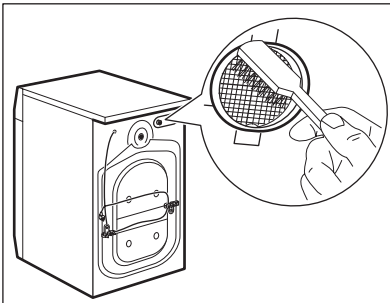

4. Remove the inlet hose behind the appliance.
5. Clean the filter in the valve with a stiff brush or a towel.

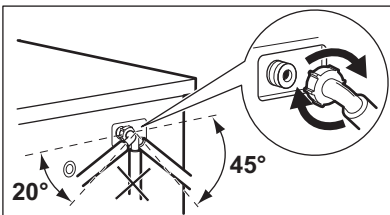

6. Install again the inlet hose. Make sure that the couplings are tight to prevent leakages.
7. Open the water tap.

14.9 Emergency drain

Because of a malfunction, the appliance cannot drain the water.

If this occurs, do steps (1) through (6) of 'To clean the drain pump'.

If necessary, clean the pump.

Put the drainage duct back and close the drain pump flap.

When you drain the water with the emergency drain procedure, you must activate again the drain system:

1. Put 2 litres of water in the main wash compartment of the detergent dispenser.
2. Start the programme to drain the water.

14.10 Frost precautions

If the appliance is installed in an area where the temperature can be less than 0 °C, remove the remaining water from the inlet hose and the drain pump.

1. Disconnect the mains plug from the mains socket.

2. Close the water tap.
3. Remove the water inlet hose
4. Put the two ends of the inlet hose in a container and let the water flow out of the hose.
5. Empty the drain pump. Refer to the emergency drain procedure
6. When the drain pump is empty, install the inlet hose again.



WARNING!

Make sure that the temperature is more than 0 °C before you use the appliance again.

The manufacturer is not responsible for damages caused by low temperatures.

15. TROUBLESHOOTING

The start of the appliance does not occur or it stops during operation. First try to find a solution to the problem (refer to the table). If not, contact the service centre.

With some problems, the acoustic signals operate and the display shows an alarm code:

- **E10** - The appliance does not fill with water.

- **E20** - The appliance does not drain the water.
- **E40** - The appliance door is open or not closed correctly.
- **EFO** - The anti-flood device is on.



WARNING!

Deactivate the appliance before you do the checks.

Problem	Possible cause	Possible solution
The appliance does not fill with water.	The water tap is closed.	Open the water tap.
	The water inlet hose is damaged.	Make sure that the water inlet hose has no damages.
	The filters in the water inlet hose is blocked .	Clean the filters. Refer to 'Care and cleaning'.
	The water tap is blocked or is furred with lime-scale.	Clean the water tap.
	The connection of the water inlet hose is not correct.	Make sure that the connection is correct.
	The water pressure is too low.	Contact your local water authority.

Problem	Possible cause	Possible solution
The appliance does not drain the water.	The water drain hose is damaged.	Make sure that the water drain hose has no damages.
	The filter of the drain pump is blocked.	Clean the filter of the drain pump. Refer to 'Care and cleaning'.
	The connection of the water drain hose is not correct.	Make sure that the connection is correct.
	A washing programme without the drain phase is set.	Set the drain programme.
	The function Rinse & Hold is on.	Set the drain programme.
The appliance door is open or not closed correctly.		Close the door correctly.
The anti-flood device is on.		<ul style="list-style-type: none"> • Disconnect the appliance. • Close the water tap. • Contact the service centre.
The spin phase does not operate.	The spin phase is off.	Set the spin programme.
	The filter of the drain pump is blocked.	Clean the filter of the drain pump. Refer to 'Care and cleaning'.
	Balance problems with the laundry load.	Adjust manually the items in the tub and start the spin phase again.
The programme does not start.	The mains plug is not connected in the mains socket.	Put in the mains plug.
	Blow out fuse in the household fuse box.	Replace the fuse.
	You did not press button 4 .	Press button 4 .
	The delay start is set.	To start immediately the programme, cancel the delay start.
	The Child Lock function is activated.	Deactivate the Child Lock function.
There is water on the floor.	Leakages from the couplings of the water hoses.	Make sure that the couplings are tight.

Problem	Possible cause	Possible solution
	Leakages from the drain pump.	Make sure that the drain pump filter is tight.
	The water drain hose is damaged.	Make sure that the water inlet hose has no damages.
You cannot open the appliance door.	The washing programme is in operation.	Let the washing programme end.
	There is water in the drum.	Set the drain or the spin programme.
The appliance makes an unusual noise.	Incorrect level of the appliance.	Adjust the level of the appliance. Refer to 'Installation'.
	You did not remove the packaging and/or the transit bolts.	Remove the packaging and/or the transit bolts. Refer to 'Installation'.
	The load is very small.	Add more laundry in the drum.
The appliance fills with water and drain immediately.	The end of the drain hose is too low.	Make sure that the drain hose is in the correct position.
The washing results are not satisfactory.	The detergent you used was not sufficient or correct.	Increase the detergent quantity or use a different one.
	You did not remove the stubborn stains before you wash the laundry.	Use special products to remove the stubborn stains.
	Incorrect temperature was set.	Make sure that you set the correct temperature.
	Too much laundry load.	Decrease the laundry load.
The appliance does not dry or does not dry correctly.	The water tap is not turned on.	Turn the tap on.
	The drain filter is clogged.	Clean the drain filter.
	There is too much laundry in the drum.	Reduce the laundry load.
	You have set a wrong dryness level or drying time.	Set additional drying time.
The laundry is full of different colours fluff.	The fabrics washed in the cycle before released fluff of different colours.	<ul style="list-style-type: none"> • The drying phase helps to remove some fluff. • Clean the laundry with a fluff remover.

Problem	Possible cause	Possible solution
	If there is a big quantity of fluff in the drum repeat this procedure again and again:	<ul style="list-style-type: none"> • Clean the empty drum, the gasket and the door with a wet cloth. • Set a rinse cycle • Put a wool or piled fabric cloth in the drum. • Set a drying cycle of 10 minutes • Remove the old wool cloth.

After the check, activate the appliance. The programme continues from the point of interruption. If the problem occurs again, contact the service centre.

If the display shows other alarm codes, contact the service centre.

16. INSTALLATION

16.1 Fixing plate kit (4055171146)

Available from your authorized dealer.

If you install the appliance on a plinth, secure the appliance in the fixing plates. Follow the instructions supplied with the kit.

16.2 Unpacking

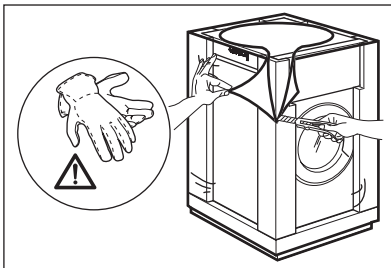

1. Use the gloves. Remove the external film. If necessary, use a cutter.

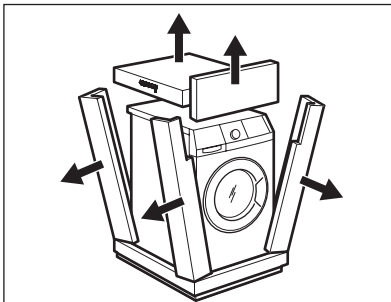

2. Remove the cardboard top.
3. Remove the polystyrene packaging materials.

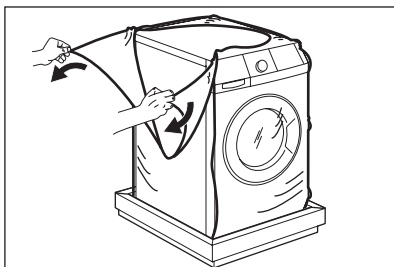

4. Remove the internal film.

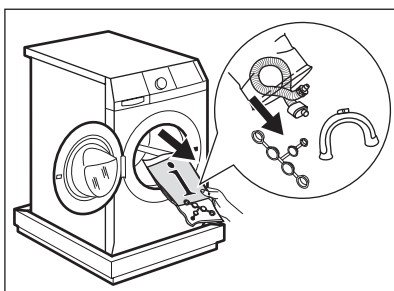

5. Open the door. Remove the polystyrene piece from the door seal and all the items from the drum.

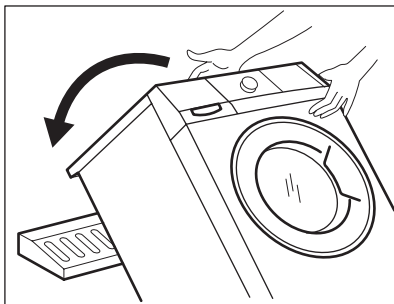

6. Put one of the polystyrene packaging elements on the floor behind the appliance. Carefully put down the appliance with the rear side on it. Make sure not to damage the hoses.

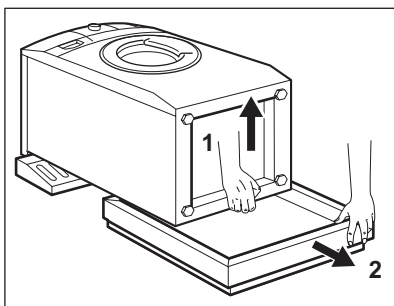

7. Remove the polystyrene protection from the bottom.

8. Pull up the appliance in vertical position.

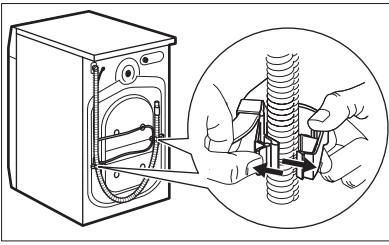

9. Remove the power supply cable and the drain hose from the hose holders.

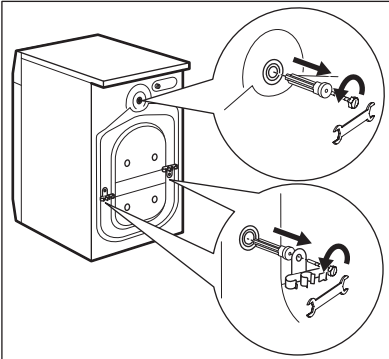

10. Remove the three bolts. Use the key supplied with the appliance.
11. Pull out the plastic spacers.

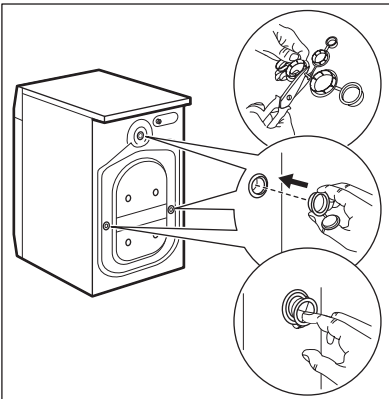

12. Put the plastic caps in the holes. You can find these caps in the user manual bag.



WARNING!

Remove all the packaging and the transit bolts before you install the appliance.



We recommend that you keep the packaging and the transit bolts for when you move the appliance.

16.3 Positioning and levelling

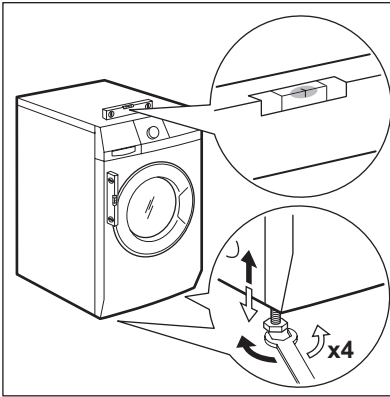

- Install the appliance on a flat hard floor.
- Make sure that carpets do not stop the air circulation below the appliance.
- Make sure that the appliance does not touch the wall or other units
- Loosen or tighten the feet to adjust the level. A correct adjustment of the appliance level prevents the vibration, noise and the movement of the appliance when in operation.

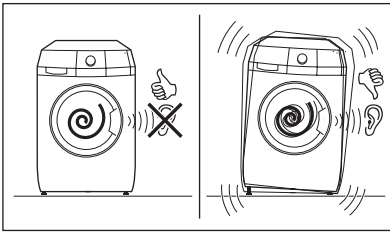

- The appliance must be level and stable.



CAUTION!

Do not put cardboard, wood or equivalent materials below the appliance feet to adjust the level.

16.4 The inlet hose

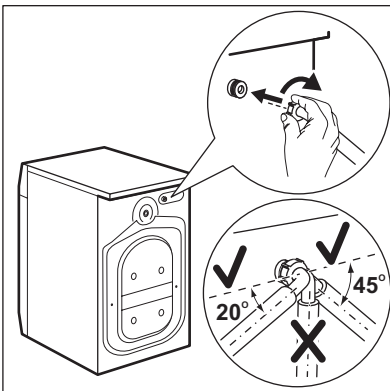

- Connect the hose to the appliance. Turn the inlet hose only left or right. Loose the ring nut to set it in the correct position.

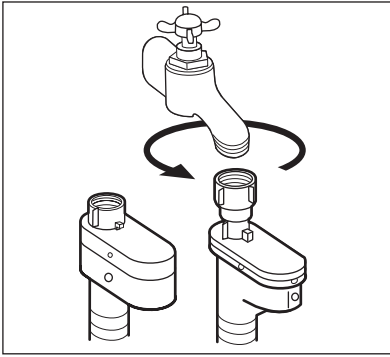

- Connect the water inlet hose to the cold water tap with 3/4 thread.



CAUTION!

Make sure that there are no leaks from the couplings.



Do not use an extension hose if the inlet hose is too short. Contact the service centre for the replacement of the inlet hose.

Water-stop device

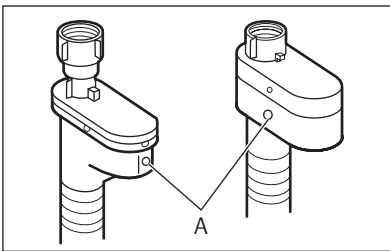

The inlet hose has a water stop device. This device prevents water leaks in the hose because of its natural ageing. The red sector in the window «A» shows this fault.

If this occur, close the water tap and contact the service centre to replace the hose.

16.5 Water drainage

There are different procedures to connect the drain hose:

With the plastic hose guide.

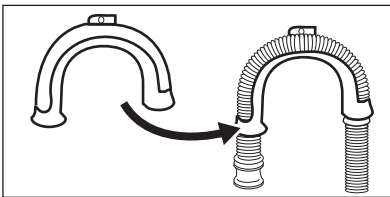

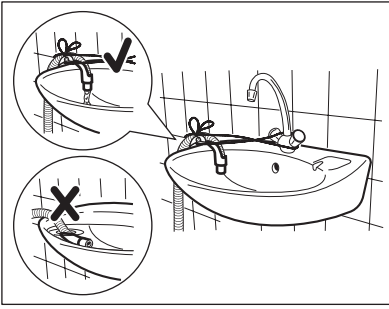

- On the edge of a sink.
- Make sure that the plastic guide cannot move when the appliance drains. Attach the guide to the water tap or the wall.

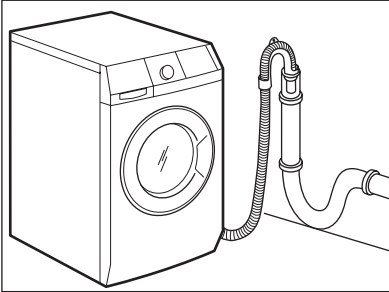

- To a stand pipe with vent-hole.
Refer to the illustration. Directly into a drain pipe at a height of not less than 60 cm and not more than 100 cm. The end of the drain hose must always be ventilated, i.e. the inner diameter of the drainpipe must be larger than the external diameter of the drain hose.

Without the plastic hose guide.

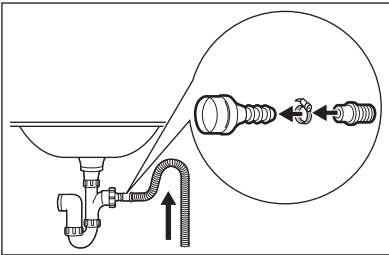

- To a sink spigot.
Refer to the illustration. Put the drain hose in the spigot and tighten it with a clip. Make sure that the drain hose makes a loop to prevent that remaining particles go in the appliance from the sink.

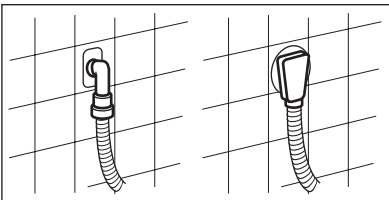



- Directly to a built-in drain pipe in the room wall and tighten it with a clip.



You can extend the drain hose to maximum 400 cm. Contact the service centre for the other drain hose and the extension.

17. ENVIRONMENT CONCERNS

Recycle the materials with the symbol . Put the packaging in applicable containers to recycle it. Help protect the environment and human health and to recycle waste of electrical and electronic

appliances. Do not dispose appliances marked with the symbol  with the household waste. Return the product to your local recycling facility or contact your municipal office.

www.aeg.com/shop



132924191-A-482012



 **AEG**
perfekt in form und funktion