



MHC002 Ceramic Hob
Manual for Installation, Use and Maintenance





Important

The CDA Group Ltd cannot be held responsible for injuries or losses caused by incorrect use or installation of this product. Please note that CDA reserve the right to invalidate the guarantee supplied with this product following incorrect installation or misuse of the appliance or use in a commercial environment.

This appliance is not designed to be used by people (including children) with reduced physical, sensorial or mental capacity, or who lack experience or knowledge about it, unless they have had supervision or instructions on how to use the appliance by someone who is responsible for their safety.

Under no circumstances should any external covers be removed for servicing or maintenance except by suitably qualified personnel.

Appliance information:

Please enter the details on the appliance rating plate below for reference, to assist CDA Customer Care in the event of a fault with your appliance and to register your appliance for guarantee purposes.

Appliance Model

Serial Number

CE Declarations of Conformity:

This appliance has been manufactured to the strictest standards and complies with all applicable legislation, including Electrical safety (LVD) 2006/95/EC and Electromagnetic interference compatibility (EMC) 2004/108/EC. Parts intended to come into contact with food conform to 89/109/EC.

IMPORTANT INFORMATION FOR CORRECT DISPOSAL OF THE PRODUCT IN ACCORDANCE WITH EC DIRECTIVE 2002/96/EC.

At the end of its working life, the product must be taken to a special local authority waste collection centre or to a dealer providing appliance recycling services.

Disposing of a household appliance separately avoids possible negative consequences for the environment and health. It also enables the constituent materials to be recovered, saving both energy and resources. As a reminder of the need to dispose of household appliances separately, the product is marked with a crossed-out wheeled dustbin. 





Please note:

- Ceramic hobs become hot and remain hot during and immediately after use. Do not touch the hob until it has been allowed to cool.
- Keep children away from the appliance when in use.
- Never put cooking foil or plastic materials on the ceramic surface when the hob is hot. These materials could melt and cause damage to the hob.
- Never use the hob top for storage.
- Pan handles should never stand out beyond the edge of the worktop. This will ensure children cannot reach them.
- Do not use pans with rough bases (e.g. cast iron) as these may scratch the hob surface.
- Do not switch on the zones without cookware in place.
- Do not lean over the hob when it is in use.
- Follow the cleaning instructions carefully.
- Ensure the base of the saucepan is clean and dry before placing it on the hob.
- After use, please ensure that all the zones have been switched off.
- This hob (Class 3) has been designed for use only as a cooking appliance. Any other use (e.g. heating rooms) should be considered incorrect and therefore dangerous.
- The appliance is not intended to be operated by any means of an external timer or separate remote-control system.

Important

- Do not use the hob if the glass surface is cracked or damaged to prevent risk of electric shock. Disconnect it from the power supply.

Using your hob

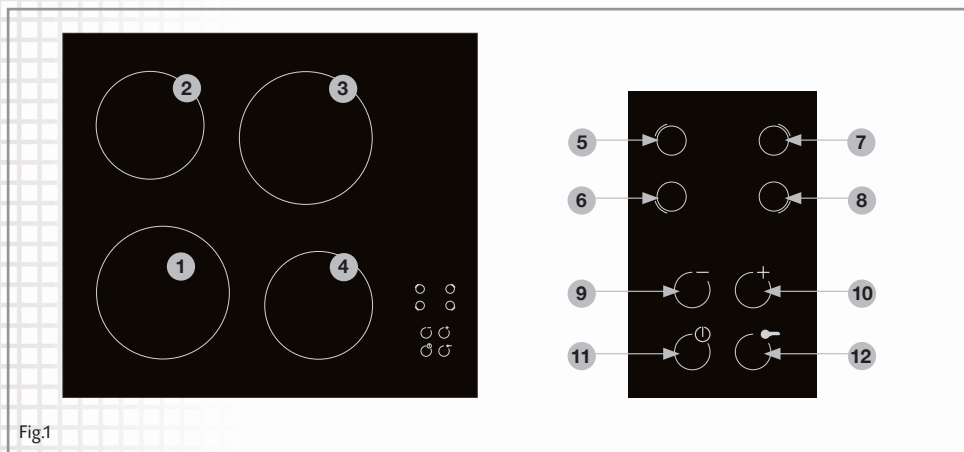

Fig.1

Zones:

1. Front left 1.8 kW 180 mm
2. Back left 1.2 kW 145 mm
3. Back right 1.8 kW 180 mm
4. Front right 1.2 kW 145 mm

5. Back left zone key
6. Front left zone key
7. Back right zone key
8. Front right zone key

9. Reduce power level key
10. Increase power level key
11. Power on/off key
12. Childlock key

Control panel:

Power level	Type of cooking
0	switched off
1/2	for melting (butter/chocolate) or keeping food warm
2/3	keeping food hot or to heat small quantities of liquid
3/4	heat larger quantities of liquid (sauces etc.)
4/5	Slow boiling, e.g spaghetti, soups, stews, potatoes
6/7	gentle frying
7/8	browning meats, frying fish, omelettes
9	fast frying steaks





Using your hob

To switch the zone on

- Touch the  key. The zone displays will flash 0 and the hob will beep to confirm the hob is on.

Please note: If a power level is not set within ten seconds, the zone will switch off automatically.

To set the power level



- Touch the zone selection key for the zone required.
- Touch the  key to increase the power level from 1 (lowest) to 9 (maximum), and the  key to reduce it.
- To go straight to power level 9, touch the  key when the zone is first switched on.

Please note:

The power level keys are only active for one zone at a time. To make a zone active when the hob is on, touch the zone selection key for that zone.

Booster function

The hob is equipped with a Booster function which will set the zone to its maximum power for a specific period of time, and then the zone will return to normal functioning.

- Once the zone is switched on, touch the  key to set the zone power level at 9, and then touch the  key again so a . (dot) or an **A** shows on the zone display for five seconds.
- Touch the  key to set the required power level between 1 and 8 within five seconds (whilst the zone display shows the . (dot) or an **A**). The hob will beep to confirm the booster is set.

To change the power level, touch the  or  keys at any time.

Once the booster function is complete, the hob will beep and the zone will return to the selected power level.

Please note:

- As 9 is the maximum power level, there is no boost function available at power level 9. Selecting power level 9 will deactivate the booster.

To switch a zone off

- Touch the zone selection key for the zone required.
- Touch the  key reduce the power level to 0 or touch the  and  keys simultaneously. The zone will switch off after approximately three seconds.

To switch the hob off

- Touch the  key.





Safety Features

Residual Heat Indicators

The hob is equipped with residual heat indicators to warn when any of the zones are still hot to the touch after cooking. An **H** will flash in the relevant zone display after cooking until the zone is at a safe temperature to touch. In the event of a power cut, the residual heat indicators will illuminate after the power supply is restored. However, whilst there is no power supply to the hob the residual heat indicators will not work, so extra care must be taken.

Overflow Protection

The hob is equipped with a sensor that will switch off the hob in any of the following situations:

- Overflow from the pan spills over the control keys
- A damp cloth is placed over the control keys
- A metallic object is placed over the control keys

Auto-stop Protection

This hob is equipped with a safety feature designed to switch off the appliance in the event that it is left on unintentionally.

The childlock

The hob is equipped with a childlock to lock the controls. This can be used when the hob is off or during cooking

To set the childlock

Touch the  key for approximately three seconds until the LED above the childlock key illuminates and the hob beeps to confirm the childlock is switched on.

To turn off the childlock

Touch the  key for approximately three seconds until the LED above the childlock key goes out and the hob beeps to confirm the childlock is switched off.

Please note:

It is possible to switch off a zone when the childlock is on for safety reasons.



Efficient Use of your Hob

Before using your hob for the first time, switch the zones on for a FEW SECONDS to burn off any grease left over from the manufacturing process

The ceramic glass retains heat, so to make best use of the residual heat, switch off the zone five minutes prior to the end of cooking.

To reduce the cooking time, the zone can be set to the maximum setting at the beginning of cooking, and then reduced during cooking time.

The hob is equipped with zones of different sizes, designed to accommodate most shapes and sizes of pan. For best results, only use pans with flat bottoms and choose an appropriate zone depending on the size of the pan. The most efficient use of the hob is shown below, where the pan and zone are correctly chosen.

Use pan lids where possible to minimise the energy usage of your appliance.

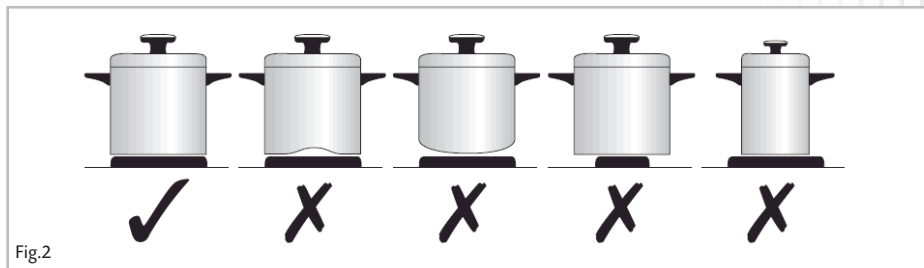

Zone Size	Minimum Pan Size (mm)	Maximum Pan Size (mm)
145	120	160
180	160	200

It is very important that the pans used on the hob are made of a suitable material and have the correct type of base. The base should be flat and smooth, as any rough part on the pan base could scratch the ceramic hob top.

Choose pans which are between the sizes recommended in the table above, and with bases that are as non-reflective as possible, e.g. dull and dark.

Only pans recommended for use on ceramic hobs should be used.



Care and Maintenance

Always disconnect the appliance from the power supply before undertaking any cleaning or maintenance.

You should use a non-abrasive cleaner to clean the hob top. Any abrasive cleaner (including Cif) will scratch the surface and could erase the control panel markings.

Types of residues	Clean with	Cleaning advice
Light	Cleaning sponge and soft cloth	Wipe over the zone to be cleaned with a sponge and hot water, and then wipe off with a soft dry cloth.
Accumulated baked-on stains / dirt, sugar spills or melted plastics	Cleaning sponge or glass scraper and soft cloth	Wipe over the zone to be cleaned with a sponge and hot water, using a ceramic scraper to remove any large marks or stains and then wipe off with a soft dry cloth.
Rings and hard water residues	White vinegar and soft cloth	Pour a small amount of warm white vinegar onto the stain, leave it to stand, and then wipe off with a soft dry cloth.

Important:

- Steam cleaners must not be used when cleaning this appliance.

Mains electrical voltage: 230 – 240Vac

Total rated electrical consumption: 6 kW

If your Hob is not working:

1. Check that the required zone is switched on.
2. Check that the mains supply has not been switched off.
3. Check that the fuse in the spur has not blown.
4. Check that the brass link wires have been fitted inside the terminal block as shown in figure 3

Contact CDA Customer Care

A : Customer Care Department, The CDA Group Ltd, Harby Road, Langar, Nottinghamshire, NG13 9HY

T : 01949 862 012 F : 01949 862 003 E : service@cda.eu W : www.cda.eu



Mains Electricity Connection

Warning! This appliance must be earthed

We recommend that the appliance is connected by a qualified electrician, who is a member of the N.I.C.E.I.C. and who will comply with the I.E.E. and local regulations.

This appliance is intended to be connected to fixed wiring and is not suitable for connection to a 13A plug or 13A supply.

This appliance is intended to be connected to fixed wiring by a double pole switch, having a contact separation of at least 3mm in all poles. The switch must be positioned no further than 2m from the appliance.

Please note:

- This appliance is intended to be connected to the mains supply with a cable of cross section area 2.5 mm². A larger cable may not fit the terminal connections.
- The marking of the current rating of the fuse or circuit breaker protecting this appliance should be marked on the socket outlet.
- Assembly and electrical connection should be carried out by specialised personnel.
- When installing this product we recommend you seek the help of another individual.

220-240V 1N ~ H05V2V2-F 3G

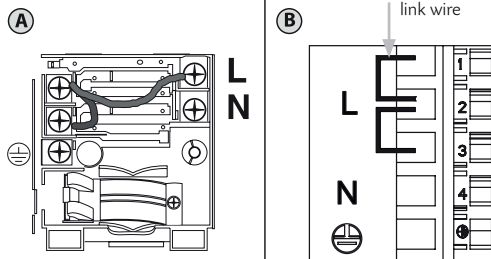

Fig.3

Use a 32A fuse breaker



Fitting the Hob

Unpacking the hob:

- Take care not to lose or mishandle any parts.

Fitting position of the hob:

This appliance must be installed a minimum of 50mm from any back wall and a minimum of 190mm away from any adjacent vertical surfaces, e.g. a tall cupboard end panel. This may be reduced to 100mm if the adjacent surface is resistant to fire (tiles or steel, for example). These dimensions are shown in Fig.4.

If fitting a cooker hood above the hob:

If a cooker hood is to be installed above the hob, the height of the hood above the hob must be at least 600mm (650mm is recommended) (Fig.5). If the instructions supplied with the hood dictate that the hood must be installed at a height greater than 600mm, then that height is the minimum required.

Wall furniture requirements:

The minimum height of any cabinet immediately above the hob is 900mm. The minimum height of any adjacent units (including light pelmets) is 400mm, unless they are manufactured from a material resistant to fire (steel, for example)

Notes:

- Do not position this appliance above a refrigeration unit. The heat generated may cause the refrigeration unit to fail.
- This appliance is designed to be installed into cabinet units capable of withstanding temperatures of 65°C or greater above ambient temperature.
- If there is no oven to be built in below the hob, an isolation shelf should be fitted to protect the user from high temperatures. If the hob is to be installed above a working drawer, then a partition should be fitted to protect the contents and user from the heat generated during use. This should be fitted 100mm below the hob.
- Never place perishable foods in the cupboard below the appliance.



How to Install the Hob

How to install the hob:

Overall dimensions of the hob: Width: 580mm Depth: 510mm

Worktop cut-out dimensions: Width: 560mm Depth: 490mm

1. Make the required hole in the worktop. Before doing this, you must check the instructions supplied with any cooker hood to ensure that you will have the required clearance. The cut-out (Fig.4) shows a 60mm gap from the wall to the cut-out edge. The distance from the hob, when fitted, to the back wall is 50mm. If a splashback/worktop upstand is to be fitted, take this into account when cutting the hole. The minimum distance that the hob should be positioned away from the rear wall or splashback is 50mm.
2. Position the hob seal, as shown in Fig.6, ensuring that the ends meet without overlapping. Do not use silicone type sealant.
3. Secure the hob to the worktop using the fixing brackets and screws supplied, as shown in Fig.7. Remove any excess sealant after tightening the brackets. Do not over-tighten the fixing brackets.

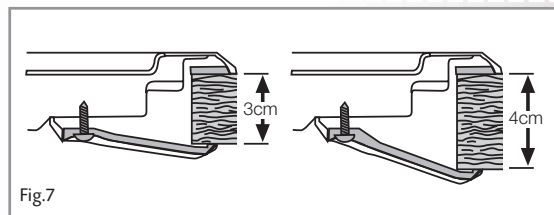
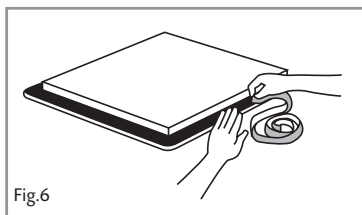
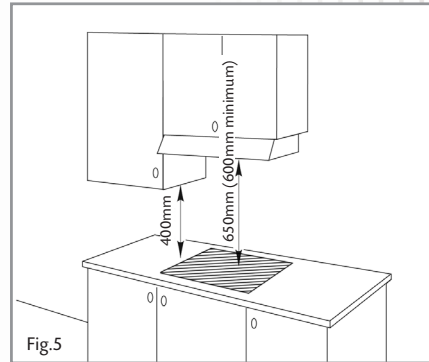
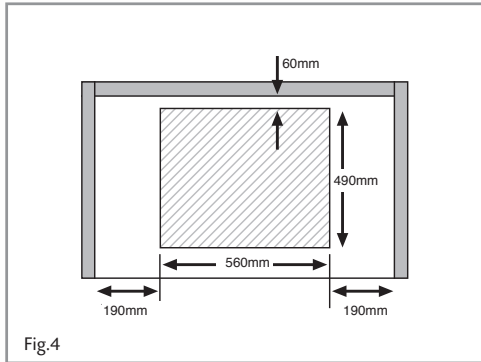



Serviced by



To contact our Customer Care Department, or for Service,
please contact us on the details below.

Customer Care Department • The CIDA Group Ltd. • Harby Road • Langar • Nottinghamshire • NG13 9HY
T : 01949 862 012 F : 01949 862 003 E : service@cda.eu W : www.cda.eu

