



## OWNER'S MANUAL

# WASHER- DRYER

---



Before beginning installation, read these instructions carefully. This will simplify installation and ensure that the product is installed correctly and safely. Leave these instructions near the product after installation for future reference.

**EN ENGLISH**

FWV917WTS V9WD107H2S F4DV910H2  
V9WD96H2 V9WD960 F4DV909H2 FWV996WTS



MFL71408054  
Rev.01\_082619

[www.lg.com](http://www.lg.com)

Copyright © 2019 LG Electronics Inc. All Rights Reserved

# TABLE OF CONTENTS

This manual may contain images or content different from the model you purchased.

This manual is subject to revision by the manufacturer.

|  |           |
|--|-----------|
| <b>IMPORTANT SAFETY INSTRUCTIONS .....</b> | <b>3</b>  |
| READ ALL INSTRUCTIONS BEFORE USE .....     | 3         |
| WARNING .....                              | 3         |
| CARING FOR THE ENVIRONMENT .....           | 8         |
| Disposal of Your Old Appliance .....       | 8         |
| <b>INSTALLATION .....</b>                  | <b>9</b>  |
| Parts and Specifications .....             | 9         |
| Installation Place Requirements .....      | 11        |
| Unpacking the Appliance .....              | 12        |
| Levelling the Appliance .....              | 13        |
| Connecting the Water Inlet Hose .....      | 14        |
| Installing the Drain Hose .....            | 16        |
| <b>OPERATION .....</b>                     | <b>17</b> |
| Operation Overview .....                   | 17        |
| Preparing the Wash Load .....              | 17        |
| Adding Detergents and Softeners .....      | 18        |
| Control Panel .....                        | 21        |
| Programme Table .....                      | 22        |
| Extra Options and Functions .....          | 27        |
| <b>SMART FUNCTIONS .....</b>               | <b>31</b> |
| Using LG SmartThinQ Application .....      | 31        |
| Using Smart Diagnosis .....                | 33        |
| <b>MAINTENANCE .....</b>                   | <b>35</b> |
| Cleaning After Every Wash .....            | 35        |
| Cleaning the Appliance Periodically .....  | 35        |
| <b>TROUBLESHOOTING .....</b>               | <b>38</b> |
| Before Calling for Service .....           | 38        |
| <b>OPERATING DATA .....</b>                | <b>45</b> |
| Product Fiche .....                        | 45        |

## READ ALL INSTRUCTIONS BEFORE USE

The following safety guidelines are intended to prevent unforeseen risks or damage from unsafe or incorrect operation of the appliance.

The guidelines are separated into 'WARNING' and 'CAUTION' as described below.

### Safety Messages



This symbol is displayed to indicate matters and operations that can cause risk. Read the part with this symbol carefully and follow the instructions in order to avoid risk.



#### **WARNING**

This indicates that the failure to follow the instructions can cause serious injury or death.



#### **CAUTION**

This indicates that the failure to follow the instructions can cause the minor injury or damage to the product.

## WARNING



#### **WARNING**

**To reduce the risk of explosion, fire, death, electric shock, injury or scalding to persons when using this product, follow basic precautions, including the following:**

## Technical Safety

- This appliance can be used by children aged from 8 years and above and persons with reduced physical, sensory or mental capabilities or lack of experience and knowledge if they have been given supervision or instruction concerning use of the appliance in a safe way and understand the hazards involved. Children shall not play with the appliance. Cleaning and user maintenance shall not be made by children without supervision.
- Children of less than 3 years should be kept away unless continuously supervised.
- If the power cord is damaged, it must be replaced by the manufacturer, its service agent or similarly qualified persons in order to avoid a hazard.
- Ventilation openings must not be obstructed by a carpet.
- This appliance is intended to be used in household only and not in applications such as;
  - Staff kitchen areas in shops, offices and other working environments;
  - Farm houses;
  - By clients in hotels, motels and other residential type environments;
  - Bed and breakfast type environments;
  - Areas for communal use in blocks of flats or in laundrettes
- Use a new hose or hose-set supplied with the appliance. Reusing old hoses can cause a water leak and subsequent property damage.
- The water pressure must be between 100 and 1000 kPa.
- The maximum capacity in some cycles for dry clothes to be used:

|   |   |
|---|---|
| <b>FWV917WTS V9WD107H2S<br/>F4DV910H2</b> | <b>V9WD96H2 V9WD960<br/>F4DV909H2 FWV996WTS</b> |
| <b>10.5 kg (Wash) / 7 kg (Dry)</b>        | <b>9 kg (Wash) / 6 kg (Dry)</b>                 |

## Installation

- Never attempt to operate the appliance if it is damaged, malfunctioning, partially disassembled, or has missing or broken parts, including a damaged cord or plug.
- This appliance should only be transported by two or more people holding the appliance securely.
- Do not install the appliance in a damp and dusty place. Do not install or store the appliance in any outdoor area, or any area that is subject to weathering conditions such as direct sunlight, wind, or rain or temperatures below freezing.
- Tighten the drain hose to avoid separation.
- If the power cord is damaged or the hole of the socket outlet is loose, do not use the power cord and contact an authorized service centre.
- Do not plug multiple socket outlets, an extension power cable or adapter with this appliance.
- This appliance must not be installed behind a lockable door, a sliding door or a door with a hinge on the opposite side to that of the appliance, in such a way that a full opening of the appliance door is restricted.
- This appliance must be grounded. In the event of malfunction or breakdown, grounding will reduce the risk of electric shock by providing a path of least resistance for electric current.
- This appliance is equipped with a power cord having an equipment grounding conductor and a grounding power plug. The power plug must be plugged into an appropriate socket outlet that is installed and grounded in accordance with all local codes and ordinances.
- Improper connection of the equipment-grounding conductor can result in risk of electric shock. Check with a qualified electrician or service personnel if you are in doubt as to whether the appliance is properly grounded.
- Do not modify the power plug provided with the appliance. If it does not fit the outlet, have a proper outlet installed by a qualified electrician.

## Operation

- Do not attempt to separate any panels or disassemble the appliance.
- Do not apply any sharp objects to the control panel in order to operate the appliance.
- Do not repair or replace any part of the appliance. All repairs and servicing must be performed by qualified service personnel unless specifically recommended in this Owner's Manual. Use only authorized factory parts.
- Do not put animals, such as pets into the appliance.
- Keep the area underneath and around the appliance free of combustible materials such as lint, paper, rags, chemicals, etc.
- Do not leave the appliance door open. Children may hang on the door or crawl inside the appliance, causing damage or injury.
- Use new hose or hose-set supplied with the appliance. Reusing old hoses can cause a water leak and subsequent property damage.
- Do not put in, wash or dry articles that have been cleaned in, washed in, soaked in, or spotted with combustible or explosive substances (such as waxes, wax removers, oil, paint, gasoline, degreasers, drycleaning solvents, kerosene, petrol, spot removers, turpentine, vegetable oil, cooking oil, acetone, alcohol, etc.). Improper use can cause fire or explosion.
- Never reach into the appliance while it is operating. Wait until the drum has completely stopped.
- In case of flood, disconnect the power plug and contact the LG Electronics customer information centre.
- Do not push down the door excessively, when the appliance door is open.
- Do not touch the door during a high temperature programme.
- Do not use flammable gas and combustible substances (benzene, gasoline, thinner, petroleum, alcohol, etc.) near the appliance.

- If the drain hose or inlet hose is frozen during winter, use it only after thawing.
- Keep all washing detergents, softener and bleach away from children.
- Do not touch the power plug or the appliance controls with wet hands.
- Do not bend the power cable excessively or place a heavy object on it.
- Do not wash rugs, mats, shoes or pet blankets, or any other items other than clothes or sheets, in this machine.
- This appliance must only be used for domestic household purposes and should not be used in mobile applications.
- If there is a gas leakage (isobutane, propane, natural gas, etc.), do not touch the appliance or power plug and ventilate the area immediately.

### **Technical Safety for Using the Dryer**

- Do not dry unwashed items in the appliance.
- Items that have been soiled with substances such as cooking oil, vegetable oil, acetone, alcohol, petroleum, kerosene, spot removers, turpentine, waxes and wax removers should be washed in hot water with an extra amount of detergent before being dried in the appliance.
- Never stop the appliance before the end of the drying cycle unless all items are quickly removed and spread out so that the heat is dissipated.
- Items such as foam rubber (latex foam), shower caps, waterproof textiles, rubber backed articles and clothes or pillows fitted with foam rubber pads should not be dried in the appliance.
- Fabric softeners, or similar products, should be used as specified by the fabric softener instructions.
- Remove all objects from pockets such as lighters and matches.
- The appliance is not to be used if industrial chemicals have been used for cleaning.

## Maintenance

- Securely plug the power plug in the socket outlet after completely removing any moisture and dust.
- Disconnect the appliance from the power supply before cleaning the appliance. Setting the controls to the OFF or stand by position does not disconnect this appliance from the power supply.
- Do not spray water inside or outside the appliance to clean it.
- Never unplug the appliance by pulling on the power cable. Always grip the power plug firmly and pull straight out from the socket outlet.

## Disposal

- Before discarding an old appliance, unplug it. Cut off the cable directly behind the appliance to prevent misuse.
- Dispose of all packaging materials (such as plastic bags and styrofoam) away from children. The packaging materials can cause suffocation.
- Remove the door before disposing of or discarding this appliance to avoid the danger of children or small animals getting trapped inside.

## CARING FOR THE ENVIRONMENT

### Disposal of Your Old Appliance



- This crossed-out wheeled bin symbol indicates that waste electrical and electronic products (WEEE) should be disposed of separately from the municipal waste stream.
- Old electrical products can contain hazardous substances so correct disposal of your old appliance will help prevent potential negative consequences for the environment and human health. Your old appliance may contain reusable parts that could be used to repair other products, and other valuable materials that can be recycled to conserve limited resources.
- You can take your appliance either to the shop where you purchased the product, or contact your local government waste office for details of your nearest authorised WEEE collection point. For the most up to date information for your country, please see [www.lg.com/global/recycling](http://www.lg.com/global/recycling).



## Parts and Specifications

### NOTE

- Appearance and specifications may change without notice to improve the quality of the appliance.

### Front View

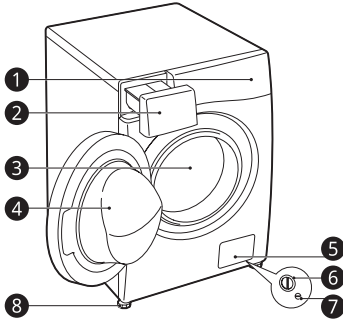

- 1 Control Panel
- 2 Detergent dispenser drawer
- 3 Drum
- 4 Door
- 5 Cover cap
- 6 Drain pump filter
- 7 Drain plug
- 8 Adjustable feet

### Rear View

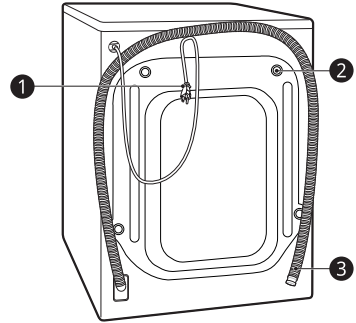

- 1 Power plug
- 2 Transit bolts
- 3 Drain hose

## Accessories

\* This feature is only available on some models.

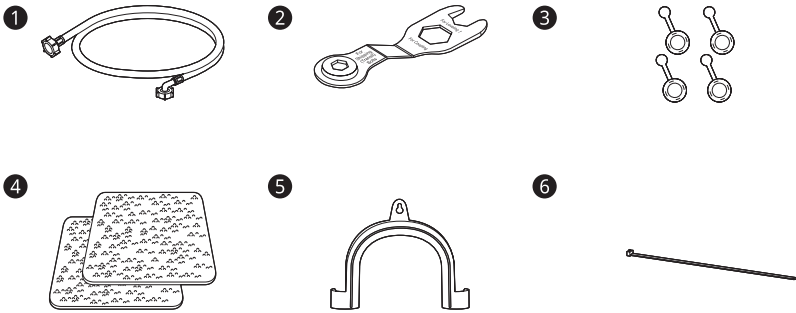

- ❶ Cold water inlet hose\*
- ❷ Spanner
- ❸ Caps for covering transit bolt holes\*
- ❹ Anti-slip sheets\*
- ❺ Elbow bracket for securing drain hose\*
- ❻ Tie strap\*

## Specifications

| Model                              | FWV917WTS<br>V9WD107H2S<br>F4DV910H2  | V9WD96H2<br>V9WD960<br>F4DV909H2<br>FWV996WTS |
|------------------------------------|---------------------------------------|---|
| Wash Capacity                      | <b>10.5 kg (Wash) /<br/>7 kg(Dry)</b> | <b>9 kg (Wash) /<br/>6kg(Dry)</b>             |
| Power Supply                       | 220 - 240 V~, 50 Hz                   |   |
| Dimension (Width x Depth x Height) | 600 mm X 560 mm X 850 mm              |   |
| Product Weight                     | 73 kg                                 |   |

- No further backflow protection required for connection to the water inlet.

## Installation Place Requirements

Before installing the appliance, check the following information to make sure that the appliance should be installed in a correct place.

### Installation Location

- Install the appliance on a flat hard floor. (Allowable slope under the appliance: 1°)
- Never try to correct any unevenness in the floor with pieces of wood, cardboard or similar materials under the appliance.
- If it is impossible to avoid positioning the appliance next to a gas cooker or coal burning stove, an insulation (850 X 600 mm) covered with aluminium foil on the side facing the cooker or stove must be inserted between the two appliances.
- Ensure that when the appliance is installed, it is easily accessible for an engineer in the event of a breakdown.
- With the appliance installed, adjust all four feet using the transit bolt spanner provided to ensure the appliance is stable, and a clearance of approximately **5 mm** is left between the top of the appliance and the underside of any worktop.
- Additional clearance should have **100 mm** for the wall and **20 mm** for rear, right and left side.

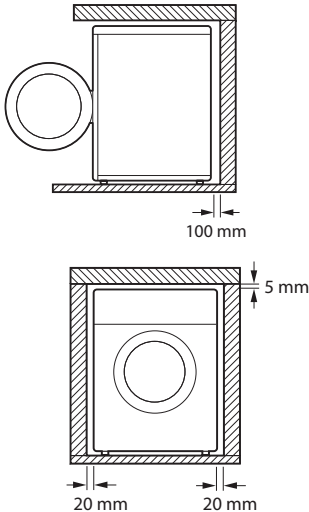

### WARNING

- This appliance must only be used for domestic household purposes and should not be used in mobile applications.

### NOTE

- If the appliance is installed on a raised platform, it must be securely fastened in order to eliminate the risk of falling off.

### Wooden Floors (Suspended Floors)

When installing the appliance on wooden floors, use rubber cups to prevent the appliance from excessive vibration and unbalance.

- To prevent vibration, we recommend you to place rubber cups  at least 15 mm thick of the each foot of the appliance, secured to at least two floor beams with screws.

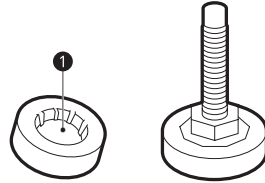

- If possible, install the appliance in one of the corners of the room, where the floor is more stable.
- Fit the rubber cups to reduce vibration.

### CAUTION

- This appliance must only be used for domestic household purposes and should not be used in mobile applications.
- If the appliance is installed on the unstable floor (e.g. wooden floor), the warranty does not cover any damages and cost occurred due to the installation on the unstable floor.

### NOTE

- You can purchase rubber cups (Part No. **4620ER4002B**) from the LG Electronics service centre.

## Ventilation

- Make sure that air circulation around the appliance should not be impeded by carpets, rugs, etc.

## Ambient Temperature

- Do not install the appliance in rooms where freezing temperatures may occur. Frozen hoses may burst under pressure. The reliability of the electronic control unit may be impaired at temperatures below freezing point.
- If the appliance is delivered in winter and temperatures are below freezing, place the appliance at room temperature for a few hours before putting it into operation.

## Electrical Connection

- Do not use an extension cord or double adapter.
- Always unplug the appliance and turn off the water inlet after use.
- Connect the appliance to an earthed socket in accordance with current wiring regulations.
- The appliance must be positioned so that the plug is easily accessible.
- Power outlet must be at least 1 meter of either side of the location of the appliance.

## WARNING

- Repairs to the appliance must only be carried out by the qualified personnel. Repairs carried out by inexperienced persons may cause injury or serious malfunctioning. Contact your LG Electronics service centre.
- The power plug must be plugged into an appropriate socket outlet that is installed and grounded in accordance with all local codes and ordinances.

## Unpacking the Appliance

### Lifting the Appliance Off the Foam Base

\* This feature is only available on some models.

After removing the carton and shipping material, lift the appliance off the foam base.

- Make sure the tub support **1\*** comes off with the base and is not stuck to the bottom of the appliance.
- If you must lay the appliance down to remove the carton base **2**, always protect the side of the appliance and lay it carefully on its side. Do not lay the appliance on its front or back.

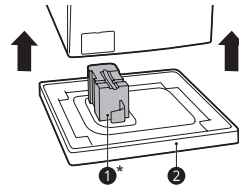

### Removing the Bolt Assemblies

- 1 Starting with the bottom two transit bolts **1**, use the spanner (included) to fully loosen all transit bolts by turning them counterclockwise.

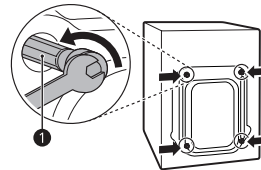

- 2 Remove the bolt assemblies by wiggling them slightly while pulling them out.

- 3 Install the hole caps.
  - Locate the hole caps ② included in the accessory pack or attached on the back.

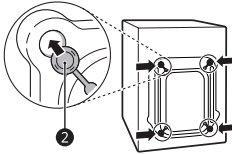

## Levelling the Appliance

### Checking the Level

When installing the appliance, the appliance should be aligned and perfectly level.

- If the appliance is not aligned and level properly, the appliance may be damaged or may not operate properly.

### Adjusting and Levelling the Feet

When installing the appliance, the appliance should be aligned and perfectly level. If the appliance is not aligned and level properly, the appliance may be damaged or may not operate properly.

- 1 Turn the adjustable feet as required if the floor is uneven.
  - Do not insert pieces of wood etc. under the feet.
  - Make sure that all four feet should be stable and resting on the floor.

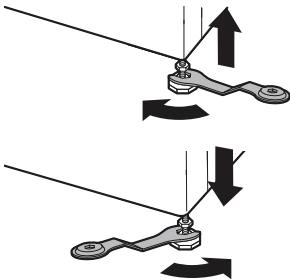

- 2 Check if the appliance is perfectly level using a spirit level ①.

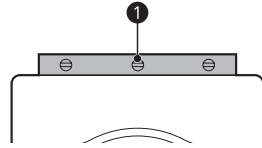

- 3 Secure the adjusting feet with the lock nuts ② by turning counterclockwise against the bottom of the appliance.

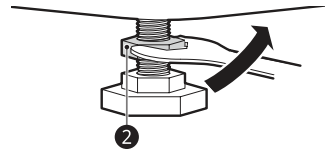

- 4 Check if all lock nuts at the bottom of the appliance are secured properly.

### NOTE

- Proper placement and levelling of the appliance will ensure long, regular, and reliable operation.
- The appliance must be horizontal and stand firmly in position.
- It must not 'Seesaw' across corners under the load.
- Do not let the feet of the appliance get wet. Failure to do so may cause vibration or noise.

### Using Anti-Slip Sheets

This feature is only available on some models.

If you install the appliance on a slippery surface, it may move because of excessive vibration. Incorrect levelling may cause malfunction through noise and vibration. If this occurs, install the anti-slip sheets under the levelling feet and adjust the level.

- 1 Clean the floor to attach the anti-slip sheets.
  - Use a dry rag to remove and clean foreign objects and moisture. If moisture remains, the anti-slip sheets may slip.

- 2 Adjust the level after placing the appliance in the installation area.
- 3 Place the adhesive side ❶ of the anti-slip sheets on the floor.
  - The most effective way is to install the anti-slip sheets under the front feet. If it is difficult to place the sheets under the front feet of the appliance, attach them under the rear feet.

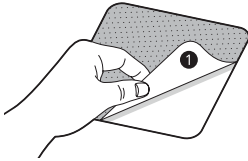

- 4 Put the appliance on the anti-slip sheets.
  - Do not attach the adhesive side ❶ of anti-slip sheets to the feet of the appliance.

#### NOTE

- Additional anti-slip sheets are available at LG Electronics service centre.

## Connecting the Water Inlet Hose

### Note for Connection

- Water pressure must be between **100 kPa** and **1000 kPa** (1.0 - 10.0 kgf/cm<sup>2</sup>). If the water pressure is more than **1000 kPa**, a decompression device should be installed.
- Do not overtighten the water inlet hose to all valves.
- Periodically check the condition of the hose and replace the hose if necessary.

## Checking the Rubber Seal on the Water Inlet Hose

Two rubber seals ❶ are supplied with the water inlet hoses. They are used to prevent water leaks. Make sure that the connection to taps should be sufficiently tight.

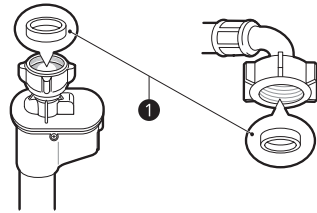
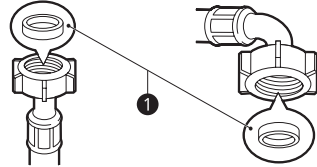

## Connecting Hose to Water Tap

### Screw - Type Hose to Tap with Thread

Screw the hose connector to the water supply, which has 3/4" threaded union.

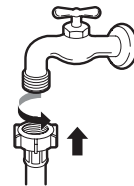

**NOTE**

- Before connecting the inlet hose to the water tap, turn on the water tap to flush out foreign substances (dirt, sand, sawdust, and etc.) in the water lines. Let the water drain into a bucket, and check the water temperature.

**Connecting Screw-Type Hose to Tap Without Thread**

- 1 Loosen the four fixing screws.

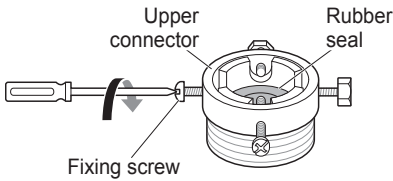

- 2 Remove the guide plate if the tap is too large to fit the adapter.

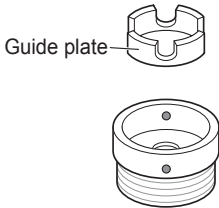

- 3 Push the adapter onto the end of the tap so that the rubber seal forms a watertight connection. Tighten the four fixing screws.

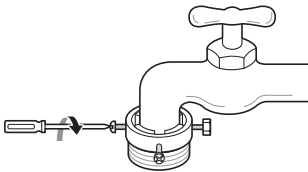

- 4 Push the supply hose vertically upwards so that the rubber seal within the hose can adhere completely to the tap and then tighten it by screwing it to the right.

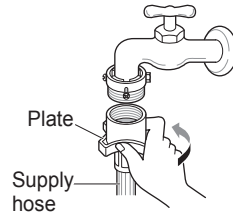
**Connecting One Touch Type Hose to Tap Without Thread**

- 1 Unscrew the adapter ring plate and loose the four fixing screws.

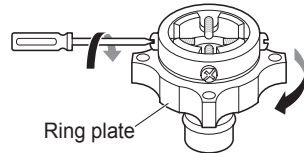

- 2 Remove the guide plate if the tap is too large to fit the adapter.

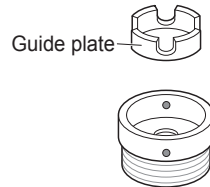

- 3 Push the adapter onto the end of the tap so that the rubber seal forms a watertight connection. Tighten the four fixing screws and the adapter ring plate.

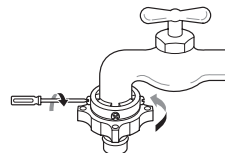

- 4 Pull the connector latch plate down, push the supply hose onto the adapter, and release the connector latch plate. Make sure the adapter locks into place.

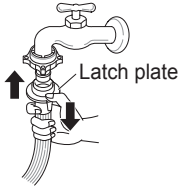

#### NOTE

- After connecting the supply hose to the water tap, turn on the water tap to flush out foreign substances (dirt, sand, sawdust, and etc.) in the water lines. Let the water drain into a bucket, and check the water temperature.

### Connecting Hose to the Appliance

Screw the water line to the water supply on the back of the appliance.

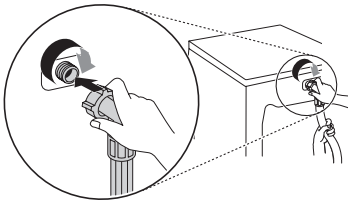

#### NOTE

- After completing connection, if water leaks from the hose, repeat the same steps. Use the most conventional type of tap for the water supply. If the tap is square or too big, remove the guide plate before inserting the tap into the adaptor.
- Make sure that the hose should not be kinked or trapped.

## Installing the Drain Hose

### For Model with Drain Pump

The drain hose should not be placed higher than **100 cm** above the floor. Water in the appliance may not drain or may drain slowly.

- Securing the drain hose correctly will protect the floor from damage due to water leakage.

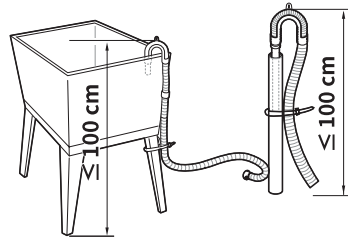
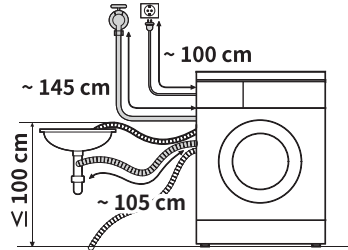

- If the drain hose is too long, do not force it back into the appliance. This will cause abnormal noise.
- When installing the drain hose to a sink, secure it tightly with string.

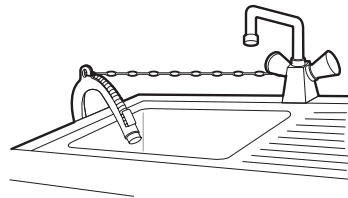



## Operation Overview

### Using the Appliance

Before the first wash, select the **Cotton** wash programme and add a half amount of the detergent. Start the appliance without laundry. This will remove possible residues and water from the drum that may have been left during manufacturing.

- 1 Sort laundry and load items.
  - Sort laundry by fabric type, soil level, colour and load size as needed. Open the door and load items into the appliance.
- 2 Add detergent or softener.
  - Add the proper amount of detergent to the detergent dispenser drawer. If desired, add bleach or fabric softener to the appropriate areas of the dispenser.
- 3 Turn on the appliance.
  - Press the **Power** button to turn on the appliance.
- 4 Choose the desired cycle.
  - Press the cycle button repeatedly or turn the cycle selector knob until the desired cycle is selected.
  - Now select a wash temperature and spin speed. Pay attention to the care labeling of your clothes.
- 5 Begin cycle.
  - Press the **Start/Pause** button to begin the cycle. The appliance will agitate briefly without water to measure the weight of the load. If the **Start/Pause** button is not pressed within **15 minutes**, the appliance will shut off and all settings will be lost.

- 6 End of cycle.
  - When the cycle is finished, a melody will sound. Immediately remove your clothing from the appliance to reduce wrinkling. Check around the door seal when removing the load for small items that may be caught in the seal.

## Preparing the Wash Load

Sort laundry for best washing results, and then prepare laundry according to the symbols on the care labels.





### Sorting the Wash Load

- For best washing results, sort your clothes according to the symbol on the care labels according to the type of fabric and washing temperature and wash them with adapted spin speed.
- Soil (Heavy, Normal, Light): Separate clothes according to amount of soil.
- Colour (White, Lights, Darks): Separate white fabrics from coloured fabrics. Wash new dark and colored garments separately at first.
- Lint (Lint producers, Collectors): Wash lint producers and lint collectors separately.

## Checking the Clothes Care Label

### Symbols on the care labels

The symbols tell you about the fabric content of your garment and how it should be washed.

| Symbol  | Wash / Fabric type  |
|---|---|
|  | <ul style="list-style-type: none"> <li>• Normal Wash</li> <li>• Cotton, Mixed Fabrics</li> </ul>  |
|  | <ul style="list-style-type: none"> <li>• Easy Care</li> <li>• Synthetic, Mixed Fabrics</li> </ul> |
|  | <ul style="list-style-type: none"> <li>• Special Delicate Wash</li> <li>• Delicates</li> </ul>    |
|  | <ul style="list-style-type: none"> <li>• Hand Wash Only</li> <li>• Wool, Silk</li> </ul>          |
|  | <ul style="list-style-type: none"> <li>• Do not wash</li> </ul>                                   |

**NOTE**

- The dashes under the symbol give you information about the type of fabric and the maximum allowance of mechanical stress.

**Checking the Clothes before Loading**

- Combine large and small items in a load. Load large items first.
- Large items should not be more than half of the total wash load. Do not wash single items. This may cause an unbalanced load. Add one or two similar items.
- Check all pockets to make sure that they are empty. Items such as nails, hair clips, matches, pens, coins and keys can damage both your appliance and clothes.

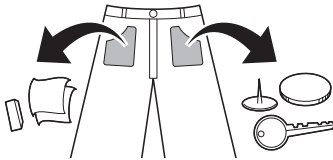

- Wash delicates (stockings, underwired bras) in a wash net.
- Close zippers, hooks and strings to make sure that these items do not snag on other clothes.
- Pre-treat dirt and stains by brushing a small amount of detergent dissolved water onto stains to help lift dirt.
- Check the folds of the flexible gasket (gray) and remove any small articles.

**! CAUTION**

- Check if the laundry gets stuck between the door and the seal, otherwise the laundry may get damaged while washing.

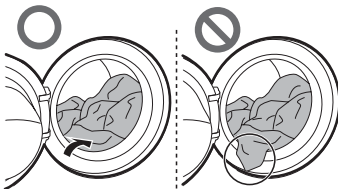

- Remove items from the flexible gasket to prevent clothing and door seal damage.

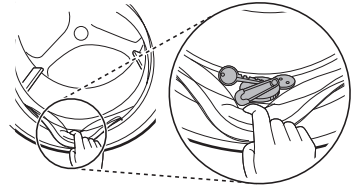
**Adding Detergents and Softeners****Detergent Dosage**



- Detergent should be used according to the instruction of the detergent manufacturer and selected according to type, colour, soiling of the fabric and the washing temperature.
- If too many suds occur, reduce the detergent amount.
- If too much detergent is used, too many suds can occur and this will result in poor washing results.
- If you wish to use liquid detergent, follow the guidelines provided by the detergent manufacturer.
- You can pour liquid detergent directly into the main detergent drawer if you are starting the wash cycle immediately.
- Do not use liquid detergent if you are using **Delay End** function, or if you have selected **Pre Wash** option, as the liquid may harden.
- Detergent usage may need to be adjusted for water temperature, water hardness, size and soil level of the load. For best results, avoid oversudsing.
- Refer to the label of the clothes, before choosing the detergent and water temperature.
- Use only suitable detergents for the respective type of clothing:
  - Liquid detergent is often designed for special applications, e.g. for coloured fabric, wool, delicate or dark laundry.
  - Powdered detergent is suitable for all types of fabric.

- For better washing results of white and pale garments, use powdered detergent with bleach.
- Detergent is flushed from the dispenser at the beginning of the wash cycle.

### NOTE

- Do not let the detergent harden. Doing so may lead to blockages, poor rinse performance or odour.
- Full load: According to manufacturer's recommendation
- Part load:  $\frac{3}{4}$  of the normal amount
- Minimum load:  $\frac{1}{2}$  of full load

### Adding Detergent

- Detergent for main wash ① only → 
- Detergent for pre wash ② and main wash ① → 

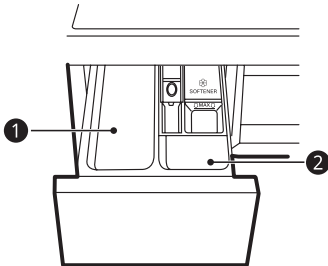

### NOTE

- Use the appropriate amount of detergent. Too much detergent, bleach or softener may cause an overflow.
- When selecting **Pre Wash**, divide the dosage into  $\frac{1}{3}$  for pre wash and  $\frac{2}{3}$  for main wash.

### Adding Detergent Tablet

Detergent tablet is also available when washing laundry.

- 1 Open the door and put detergent tablets into the drum.

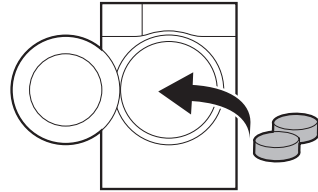

- 2 Load the laundry into the drum and close the door.

### NOTE

- Do not put tablets into the drawer.

### Adding Fabric Softener

- Do not exceed the maximum fill line. Overfilling can cause early dispensing of the fabric softener, which may stain clothes. Close the dispenser drawer slowly.

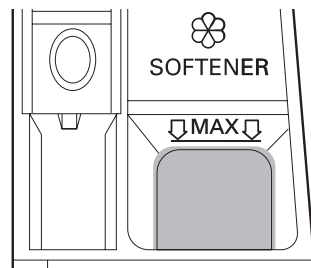

- Do not leave the fabric softener in the detergent drawer for more than 2 days (Fabric softener may harden).
- Softener will automatically be added during the last rinse cycle.
- Do not open the drawer when water is being supplied.
- Solvents (e.g. benzene, etc.) must not be used.

**NOTE**

- Do not pour fabric softener directly onto the garments, as this may cause stains on your clothing.

**Adding Water Softener**

A water softener, such as anti-limescale can be used to cut down on the use of detergent in areas with high water hardness level.

- First add detergent, and then the water softener. Dispense according to the amount specified on the packaging.

# Control Panel

## Control Panel Features

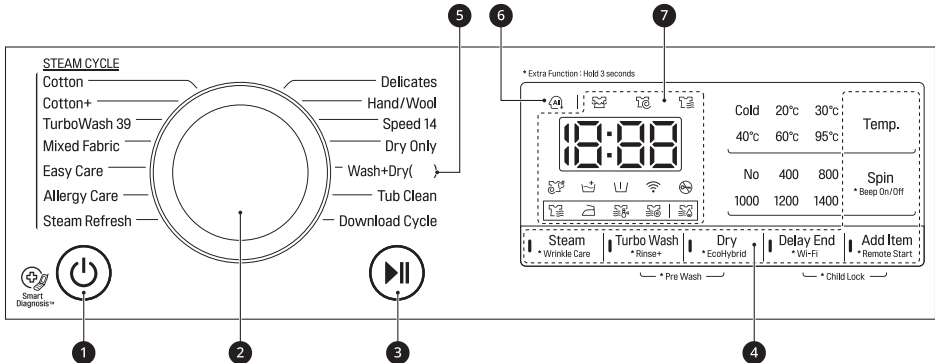

### 1 Power Button

- Press the **Power** button to turn on or off the appliance.

### 2 Programme Knob

- Programmes are available according to the laundry type.
- The lamp will light up to indicate the selected programme.

### 3 Start/Pause Button

- This **Start/Pause** button is used to start the wash cycle or pause the wash cycle.
- If a temporary stop of the wash cycle is needed, press the **Start/Pause** button.



### 4 Extra Options and Functions

- Extra options and functions are available for better washing performance. Several options and functions can be customized.
- To use the extra functions, press and hold the corresponding button for 3 seconds. The corresponding symbol lights up in the display.
- In order to use the **Remote Start** function, refer to **SMART FUNCTIONS**.
- This allows you to select an additional programmes and will light when selected.
  - : When the laundry is spun after steaming, this icon is illuminated.
  - : When the number of rinse is added, this icon is illuminated.
  - : When the heavily soiled laundry is washed intensively, this icon is illuminated.
  - : This icon is illuminated when the appliance is connected to WLAN network.





### 5 Wash+Dry()

- () indicates the drying capacity, which varies on the models.

### 6 AI DD

- **AI DD**  provides the desired washing and spinning.
-  is activated when **Cotton, Mixed Fabric, Easy Care** programmes are selected and operated.

## 7 Display

- The display shows the settings, estimated remaining time, options, and status messages. When the appliance is turned on, the default settings in the display will illuminate.
  - : When a programme is selected, the default time for that programme is displayed. The default time can be changed according to the selected option.
  - : When this icon is illuminated, the door cannot be opened.
  - : When the laundry is being washed, this icon is illuminated.
  - : When the laundry is spun to remove the water in the laundry, this icon is illuminated.
  - : When the laundry is being dried after completion of washing programme, this icon is illuminated.

# Programme Table

## Washing Programme

| Programme                 | Cotton  | Max. Load | Rating |
|---------------------------|---|-----------|--------|
| <b>Description</b>        | Provides better performance by combining various drum motions.<br>Use for coloured fast garments (shirts, nightdresses, pajamas, etc.) and normally soiled cotton load (underwear). |           |        |
| <b>Proper Temperature</b> | 40 °C (Cold to 95 °C)   |           |        |
| <b>Max. Spin Speed</b>    | 1400 rpm  |           |        |

| Programme                 | Cotton+  | Max. Load | Rating |
|---------------------------|--|-----------|--------|
| <b>Description</b>        | Provides optimised washing performance for large amount of laundry with less energy consumption.<br>Use for coloured fast garments (shirts, nightdresses, pajamas, etc.) and normally soiled cotton items (underwear). |           |        |
| <b>Proper Temperature</b> | 60 °C (Cold to 60 °C)  |           |        |
| <b>Max. Spin Speed</b>    | 1400 rpm   |           |        |

| Programme                 | TurboWash 39  | Max. Load | 5 kg |
|---------------------------|---|-----------|------|
| <b>Description</b>        | Finishes the whole cycle within 39 minutes.<br>Use for various kind of fabrics except special garments (silk/delicate, sports wear, dark clothes, wool, duvet/ curtains).<br>The cycle time will differ depending on the water supply conditions, and the load and type of laundry. |           |      |
| <b>Proper Temperature</b> | 40 °C (Cold to 60 °C)   |           |      |
| <b>Max. Spin Speed</b>    | 1400 rpm  |           |      |

|                           |   |                  |      |
|---------------------------|---|------------------|------|
| <b>Programme</b>          | <b>Mixed Fabric</b>   | <b>Max. Load</b> | 4 kg |
| <b>Description</b>        | Enables various fabrics to be washed simultaneously.<br>Use for various kind of fabrics except special garments (silk/delicate, sports wear, dark clothes, wool, duvet/curtains). |                  |      |
| <b>Proper Temperature</b> | 40 °C (Cold to 60 °C)   |                  |      |
| <b>Max. Spin Speed</b>    | 1400 rpm  |                  |      |

|                           |  |                  |      |
|---------------------------|--|------------------|------|
| <b>Programme</b>          | <b>Easy Care</b>   | <b>Max. Load</b> | 4 kg |
| <b>Description</b>        | Suitable for casual shirts that do not need ironing after washing.<br>Use for Polyamide, acrylic, polyester. |                  |      |
| <b>Proper Temperature</b> | 40 °C (Cold to 60 °C)  |                  |      |
| <b>Max. Spin Speed</b>    | 1400 rpm   |                  |      |

|                           |   |                  |      |
|---------------------------|---|------------------|------|
| <b>Programme</b>          | <b>Allergy Care</b>   | <b>Max. Load</b> | 4 kg |
| <b>Description</b>        | Helps to remove allergens such as house mites, pollen and fur.<br>Use for cotton, underwear, pillow covers, bed sheets, baby wear |                  |      |
| <b>Proper Temperature</b> | 60 °C   |                  |      |
| <b>Max. Spin Speed</b>    | 1400 rpm  |                  |      |

|                           |  |                  |                     |
|---------------------------|--|------------------|---------------------|
| <b>Programme</b>          | <b>Steam Refresh</b>   | <b>Max. Load</b> | 3 pieces of laundry |
| <b>Description</b>        | Helps to remove wrinkles within 20 mins with steam.<br>Clothes may be wet. You can put dry clothes on after hanging them for 10–30 mins.<br>Use for cotton mixed, polyester mixed dress shirts, blouses. |                  |                     |
| <b>Proper Temperature</b> | -  |                  |                     |
| <b>Max. Spin Speed</b>    | -  |                  |                     |

|                           |   |                  |      |
|---------------------------|---|------------------|------|
| <b>Programme</b>          | <b>Delicates</b>  | <b>Max. Load</b> | 3 kg |
| <b>Description</b>        | Suitable for delicate clothes such as under wear, blouse, etc |                  |      |
| <b>Proper Temperature</b> | 20 °C (Cold to 40 °C)   |                  |      |
| <b>Max. Spin Speed</b>    | 800 rpm   |                  |      |

|                           |   |                  |      |
|---------------------------|---|------------------|------|
| <b>Programme</b>          | <b>Hand/Wool</b>  | <b>Max. Load</b> | 2 kg |
| <b>Description</b>        | For hand and machine washable delicate clothes such as washable wool, lingerie, dresses etc. (Use detergent for machine washable wools). Use for Wool, Silk, hand washable clothes, delicate, easily damaged laundry. |                  |      |
| <b>Proper Temperature</b> | 30 °C (Cold to 40 °C)   |                  |      |
| <b>Max. Spin Speed</b>    | 800 rpm   |                  |      |

|                           |  |                  |      |
|---------------------------|--|------------------|------|
| <b>Programme</b>          | <b>Speed 14</b>  | <b>Max. Load</b> | 2 kg |
| <b>Description</b>        | Provides fast washing time for small loads and lightly soiled clothes. |                  |      |
| <b>Proper Temperature</b> | 20 °C (20 °C to 40 °C)   |                  |      |
| <b>Max. Spin Speed</b>    | 1400 rpm   |                  |      |

|                           |   |                  |              |
|---------------------------|---|------------------|--------------|
| <b>Programme</b>          | <b>Dry Only</b>   | <b>Max. Load</b> | Rating (Dry) |
| <b>Description</b>        | Uses the automatic programmes to dry most loads.<br>For most drying, make sure all laundry are similar in material and thickness. |                  |              |
| <b>Proper Temperature</b> | -   |                  |              |
| <b>Max. Spin Speed</b>    | 1400 rpm  |                  |              |

|                           |  |                  |              |
|---------------------------|--|------------------|--------------|
| <b>Programme</b>          | <b>Wash+Dry</b>  | <b>Max. Load</b> | Rating (Dry) |
| <b>Description</b>        | Provides a nonstop process of washing and drying in the same cycle.<br>Use for a small amount of laundry which can be dried. |                  |              |
| <b>Proper Temperature</b> | 40 °C (Cold to 95 °C)  |                  |              |
| <b>Max. Spin Speed</b>    | 1400 rpm   |                  |              |

|                    |   |  |  |
|--------------------|---|--|--|
| <b>Programme</b>   | <b>Tub Clean</b>  |  |  |
| <b>Description</b> | This is a special function to clean inside of your appliance. |  |  |

|                           |   |                  |                    |
|---------------------------|---|------------------|--------------------|
| <b>Programme</b>          | <b>Download Cycle</b>   | <b>Max. Load</b> | 1 piece of laundry |
| <b>Description</b>        | The <b>Download Cycle</b> programme allows you to download new and special washing programs to your washing machine with a smartphone.<br>The default program is on <b>Rinse + Spin</b> . |                  |                    |
| <b>Proper Temperature</b> | -   |                  |                    |
| <b>Max. Spin Speed</b>    | 1400 rpm  |                  |                    |

## NOTE

- Select the proper wash temperature and spin speed for the desired programmes.
- When washing, always pay attention to the care label of your clothes.
- Actual maximum spin speed may vary depending on the model, programme, and load conditions.



## Drying Programme

|                    |  |
|--------------------|--|
| <b>Programme</b>   | <b>Normal</b>   |
| <b>Description</b> | Reduces the drying time and energy usage during dry cycle for cottons.<br>Use for cotton or linen fabrics such as cotton towels, T-shirts. |
| <b>Max. Load</b>   | Rating   |

|                    |   |
|--------------------|---|
| <b>Programme</b>   | <b>Iron</b>    |
| <b>Description</b> | Suitable for ironing to dry clothes easily in damp condition.<br>Use for cotton or linen fabrics which is ready to get ironing at the end of programme. |
| <b>Max. Load</b>   | Rating  |

|                    |   |
|--------------------|---|
| <b>Programme</b>   | <b>Low Temp.</b>                 |
| <b>Description</b> | Suitable for drying in low temperature for less clothes damage.<br>Use for easy care textiles, synthetic fabrics. |
| <b>Max. Load</b>   | 3.5 kg  |

|                    |  |
|--------------------|--|
| <b>Programme</b>   | <b>Normal Eco</b>     |
| <b>Description</b> | Suitable for energy dry programme.<br>Use for cotton or linen fabrics such as cotton towels, T-shirts. |
| <b>Max. Load</b>   | Rating   |

| <b>Programme</b>   | <b>Time Dry 30 min.</b>                                       | <b>Time Dry 60 min.</b> | <b>Time Dry 120 min.</b> |
|--------------------|---|-------------------------|--------------------------|
| <b>Description</b> | You can change the drying time according to the maximum load. |                         |                          |
| <b>Max. Load</b>   | 1 kg  | 2 kg                    | 4 kg                     |

Set programme at 'Wash : **Cotton+**, 60 °C, 1400 RPM' and 'Dry : **Normal Eco** ()' for test in accordance with EN50229.

### NOTE

- Select maximum selectable spin speed of washing programme to ensure drying results.
- Where the amount of laundry to be washed and dried in one programme does not exceed the maximum weight permitted for the drying programme, washing and drying in one continuous sequence is recommended.

## Extra Options

| Programme     | Steam | Wrinkle Care | Turbo Wash | Rinse+ | Dry | EcoHybrid | Add Item | Pre Wash |
|---------------|-------|--------------|------------|--------|-----|-----------|----------|----------|
| Cotton        | ●     | ●            | ●          | ●      | ●   | ●         | ●        | ●        |
| Cotton+       | ●     | ●            | ●          | ●      | ●   | ●         | ●        | ●        |
| TurboWash 39  | ●     | ●            | ●*         | ●      | ●   | ●         | ●        | ●        |
| Mixed Fabric  | ●     | ●            | ●          | ●      | ●   | ●         | ●        | ●        |
| Easy Care     | ●     | ●            | ●          | ●      | ●   | ●         | ●        | ●        |
| Allergy Care  | ●*    |              |            | ●      | ●   | ●         | ●        |          |
| Steam Refresh | ●*    |              |            |        |     |           |          |          |
| Delicates     |       |              | ●          | ●      |     |           | ●        |          |
| Hand/Wool     |       |              |            | ●      |     |           | ●        |          |
| Speed 14      |       |              | ●*         | ●      | ●   | ●         | ●        |          |
| Dry Only      |       |              |            |        | ●*  | ●         | ●        |          |
| Wash+Dry      | ●     |              |            | ●      | ●*  | ●         | ●        | ●        |
| Tub Clean     |       |              |            |        |     |           |          |          |

\* This option is automatically inserted in the programme and cannot be deselected.

## Extra Options and Functions

\* This feature is only available on some models.

You can use the extra options and functions to customize the programmes.

### Steam

Use this function to use the enhanced washing performance. This option consumes low energy.

- 1 Press the **Power** button.
- 2 Select a washing programme.
- 3 Press the **Steam** button.
- 4 Press the **Start/Pause** button.

### Wrinkle Care

Use this option to reduce wrinkles by steaming after spin.

- 1 Press the **Power** button.
- 2 Select a washing programme.
- 3 Press the **Wrinkle Care** button for 3 seconds.
- 4 Press the **Start/Pause** button.

### Turbo Wash

Use this option to wash laundry in less than an hour, which saves water and energy.

- 1 Press the **Power** button.
- 2 Select a washing programme.
- 3 Press the **Turbo Wash** button
- 4 Press the **Start/Pause** button.

### Rinse

Use this option to select the number of rinse by pressing the **Rinse+** button. This option is recommended for people with detergent allergies.

#### Rinse+

Use this option to add rinse once.

### Dry

Use the automatic programmes to dry most loads. Electronic sensors measure the temperature of the exhaust to increase or decrease drying temperatures for faster reaction time and tighter temperature control.

- Cold water tap must be left on during drying cycles.
- This washing machine's automatic process from washing to drying can be selected easily.
- For most drying, make sure all laundry are similar in material and thickness.
- Do not overload the washing machine by stuffing too many articles into the drum. Items must be able to tumble freely.
- If you open the door and remove the load before the washing machine has finished its programme, remember to press the **Start/Pause** button.
- By pressing the **Dry** button, you can select: **Normal-Time (30-60-120)-Iron-Low Temp.-Normal Eco.**
- Drying programme can last up to about 7 hours.
- These drying times are given as a guide to help you set your washing machine for manual drying.
- After the end of dry, 'Ed' is displayed. 'Ed' means crease decreasing. The drying programme is already done. Press any button and take out clothes. If you do not press the **Start/Pause** button, the programme ends after about 4 hours.

## Woolen Articles

Do not tumble dry woolen articles. Pull them to their original shape and dry them flat.

## Woven and Loopknit Materials

Some woven and loopknit materials may shrink, by varying amounts, depending on their quality.

Always stretch these materials out immediately after drying.

## Permanent Press and Synthetics

Do not overload your washing machine.

Take out permanent press articles as soon as the washing machine stops to reduce wrinkles.

## Baby Clothes and Night Gowns

Always check the manufacturer's instructions.

## Rubber and Plastics

Do not dry any items made from or containing rubber or plastics, such as:

- Aprons, bibs, chair covers
- Curtains and table cloths
- Bathmats

## Fiber Glass

Do not dry fiber glass articles in your washing machine. Glass particles left in the washing machine may be picked up by your clothes and cause skin irritation.

### NOTE

- When you turn off the drying cycle of the washing machine, the drying fan motor can be operated to save itself for 60 seconds.
- Be careful when removing your clothing from the washing machine, as the clothing or washing machine may be hot.
- The estimated drying time varies from the actual drying time during the Automatic cycle. The type of fabric, size of the load, and the dryness selected affect drying time.
- When you select drying only, spinning runs automatically for energy efficiency.

## EcoHybrid

Use this feature for air condensing without water consumption.

- 1 Press the **Power** button.
- 2 Select a drying programme.
- 3 Press the **EcoHybrid** button for 3 seconds.
- 4 Press the **Start/Pause** button.

### NOTE

- This feature is available with the **Normal** or **Iron** programme.

## Delay End

Use this function to automatically start and finish the appliance after a specified time interval.

- 1 Press the **Power** button.
- 2 Select a washing programme.
- 3 Press the **Delay End** button to set a required time.
- 4 Press the **Start/Pause** button.

### NOTE

- The delay time is the time to the end of the programme, not the start. The actual running time may vary due to water temperature, wash load and other factors.
- To cancel the function, the **Power** button should be pressed.
- Avoid using liquid detergent for this function.

## Wi-Fi

When WLAN is connected, the **Wi-Fi** icon on the control panel is lit.

## Add Item

Use this option to add or remove the laundry after the washing programme is start.

- 1 Press the **Add Item** button when the LED is turned on.
- 2 Open the door after it unlocks itself.
- 3 Add or remove laundry.
- 4 Close the door and press the **Start/Pause** button.

## Pre Wash

Use this option to wash the heavily soiled laundry.

- 1 Press the **Power** button.
- 2 Select a washing programme.
- 3 Press the **Turbo Wash** and **Dry** button for 3 seconds.
- 4 Press the **Start/Pause** button.

## Child Lock

Use this function to disable the controls. This function can prevent children from changing cycles or operating the appliance.

### NOTE

- Once this function is set, all buttons are locked except the **Power** button.
- When the controls are locked,  and the remaining time are alternatively shown on the display during the wash while the child lock is engaged.
- Turning off the power will not reset this function. You must deactivate this function before you can access any other functions.

### Locking the Control Panel

- 1 Turn on the power.
- 2 Press and hold the **Delay End** and **Add Item** button for 3 seconds.
  - A beeper will sound, and  will appear on the display.

### Unlocking the Control Panel

- 1 Turn on the power.
- 2 Press and hold the **Delay End** and **Add Item** button for 3 seconds to deactivate this function.

## Temp.

You can use this option in order to select the wash and rinse temperature in combination for the selected programme. Press this button until the desired setting is lit. Cold tap water is used for all rinses.

- Select the water temperature suitable for the type of laundry you are washing. Follow the fabric care labels for best results.

## Spin

Use this option to change the spin strength. Press the **Spin** button repeatedly to change the speed level.

- 1 Press the **Power** button.
- 2 Select a washing programme.
- 3 Press the **Spin** button to select spin speed.
- 4 Press the **Start/Pause** button.

### NOTE

- When you select **No**, it will still rotate for a short time to drain quickly.

## Beep On/Off



This function operates only when the appliance is in operation.

- Press and hold the **Spin** button for 3 seconds to set the this function.

### NOTE

- Once this function is set, the setting is memorized even after the power is turned off.
- If you want to turn the beeper off, simply repeat this process.

## Using LG SmartThinQ Application

This feature is only available on the model with  or  logo.

### Before Using LG SmartThinQ

- 1 Check the distance between the appliance and the wireless router (WLAN network).
  - If the distance between the appliance and the wireless router is too far, the signal strength becomes weak. It may take a long time to register or installation may fail.
- 2 Turn off the **Mobile data** or **Cellular Data** on your smartphone.

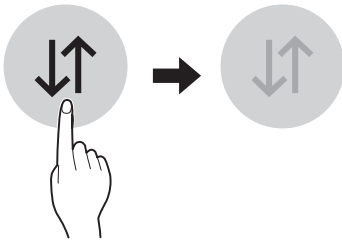

- 3 Connect your smartphone to the wireless router.

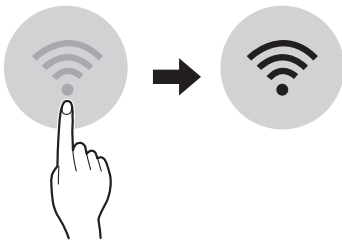

### NOTE

- To verify the WLAN connection, check that **Wi-Fi**  icon on the control panel is lit.
- The appliance supports 2.4 GHz **Wi-Fi** networks only. To check your network frequency, contact your internet service provider or refer to your wireless router manual.
- **LG SmartThinQ** is not responsible for any network connection problems or any faults, malfunctions, or errors caused by network connection.
- If the appliance is having trouble connecting to the **Wi-Fi** network, it may be too far from the router. Purchase a **Wi-Fi** repeater (range extender) to improve the **Wi-Fi** signal strength.
- The **Wi-Fi** connection may not connect or maybe interrupted because of the home network environment.
- The network connection may not work properly depending on the Internet service provider.
- The surrounding wireless environment can make the wireless network service run slowly.
- The appliance cannot be registered due to problems with the wireless signal transmission. Unplug the appliance and wait about a minute before trying again.
- If the firewall on your wireless router is enabled, disable the firewall or add an exception to it.
- The wireless network name (SSID) should be a combination of English letters and numbers. (Do not use special characters.)
- Smartphone user interface (UI) may vary depending on the mobile operating system (OS) and the manufacturer.
- If the security protocol of the router is set to **WEP**, you may fail to set up the network. Please change it to other security protocols (**WPA2** is recommended.) and register the product again.

## Installing LG SmartThinQ

Search for the **LG SmartThinQ** application from the Google Play Store or Apple App Store on a smartphone. Follow instructions to download and install the application.

## Wi-Fi Function

Communicate with the appliance from a smartphone using the convenient smart features.

### Washer Cycle (Remote Start, Download Cycle)

Set or download any preferred cycle and operate by remote control.

### Tub Clean Coach

This function shows how many cycles remain before running the **Tub Clean** cycle.

### Energy Monitoring

Check the energy consumption of the recently used cycles and monthly average.

### Smart Diagnosis

This function provides useful information for diagnosing and solving issues with the appliance based on the pattern of use.

### Settings

Various functions are available.

### Push Alert

This function is to notify the status notification so that the user can recognize the appliance status. The notifications are triggered even if the **LG SmartThinQ** application is off.

## NOTE

- If you change your wireless router, internet service provider, or password, delete the registered appliance from the **LG SmartThinQ** application and register it again.
- The application is subject to change for appliance improvement purposes without notice to users.
- Functions may vary by model.

## Using the Appliance Remotely

### Remote Start

Use a smartphone to control your appliance remotely. You can also monitor your cycle operation so you know how much time is left in the cycle.

### Using This Function

- 1 Press the **Power** button.
- 2 Put the laundry into the drum.
- 3 Press and hold **Remote Start** button for 3 seconds to enable this function.
- 4 Start a cycle from the **LG SmartThinQ** application on your smartphone.

## NOTE

- Once this function is enabled, you can start a cycle from the **LG SmartThinQ** smartphone application. If the cycle is not started, the appliance will wait to start the cycle until it is turned off remotely from the application or this function is disabled.
- When this function is turned on, the door is automatically locked.

### Disabling This Function

When this function is activated, press and hold **Remote Start** button for 3 seconds to disable this function. This function must be turned off, so that the appliance can be used manually.



## Download Cycle

Download a new and special cycle that is not included in the basic cycles on the appliance.

Appliances that have been successfully registered can download from a variety of specially cycles specific to the appliance.

Only one cycle can be stored on the appliance at a time.

Once cycle download is completed in the appliance, the product keeps the downloaded cycle until a new cycle is downloaded.

## Standby Power Consumption

|   |         |
|---|---------|
| Standby power consumption   | 0.5 W   |
| Network standby power consumption   | 2.0 W   |
| The period of time after which the power management function, or a similar function, switches the equipment automatically into standby and/or off mode and/or the condition providing networked standby | 20 min. |

## Open Source Software Notice Information



To obtain the source code under GPL, LGPL, MPL, and other open source licenses, that is contained in this product, please visit <http://opensource.lge.com>.

In addition to the source code, all referred license terms, warranty disclaimers and copyright notices are available for download.

LG Electronics will also provide open source code to you on CD-ROM for a charge covering the cost of performing such distribution (such as the cost of media, shipping, and handling) upon email request to [opensource@lge.com](mailto:opensource@lge.com).

This offer is valid for a period of three years after our last shipment of this product. This offer is valid to anyone in receipt of this information.

## Using Smart Diagnosis

This feature is only available on the model with  or  logo.

### Smart Diagnosis through the Customer Information Centre

Use this function if you need an accurate diagnosis by an LG Electronics customer information centre when the appliance malfunctions or fails. Use this function only to contact the service representative, not during the normal operation.

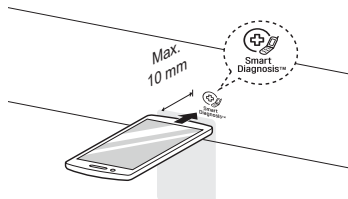
- 1 Press the **Power** button to turn on the appliance. Do not press any other buttons.
- 2 When instructed to do so by the call centre, place the mouthpiece of your phone close to the **Smart Diagnosis** icon.
 
- 3 Press and hold the **Temp.** button for 3 seconds.
- 4 Keep the phone in place until the tone transmission has finished. Time remaining for data transfer is displayed.
  - For best results, do not move the phone while the tones are being transmitted.
  - If the call centre agent is not able to get an accurate recording of the data, you may be asked to try again.
- 5 Once the countdown is over and the tones have stopped, resume your conversation with the call centre agent, who will then be able to assist you using the information transmitted for analysis.

**NOTE**

- This function depends on the local call quality.
- The communication performance will improve and you can receive better service if you use the home phone.
- If the data transfer is poor due to poor call quality, you may not receive the best diagnosis service.

## **!** WARNING

- Unplug the appliance before cleaning to avoid the risk of electric shock. Failure to follow this warning may result in serious injury, fire, electric shock, or death.
- Never use harsh chemicals, abrasive cleaners, or solvents to clean the appliance. They may damage the finish.

## Cleaning After Every Wash

### Care After Wash

- After the wash cycle is finished, wipe the door and door seal to remove any moisture.
- Leave the door slightly open to dry the drum.
- Wipe the appliance with a dry cloth to remove any moisture.

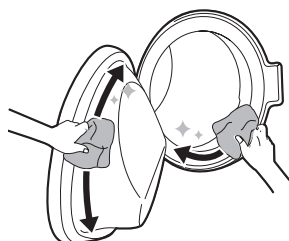

## **!** WARNING

- Leave the door open to dry the drum interior but only if it is safe and any children are supervised.

## Cleaning the Exterior

Proper care of your appliance can extend the service life.

### Exterior

Immediately wipe off any spills. Wipe with a damp cloth.

### Door

Wash with a damp cloth on the outside and inside and then dry with a soft cloth.

## **!** WARNING

- Do not attempt to separate any panels or disassemble the appliance. Do not apply any sharp objects to the control panel in order to operate the appliance.

## Cleaning the Interior

- Use a towel or soft cloth to wipe around the door opening and door glass.
- Always remove items from the appliance as soon as the cycle is complete. Leaving damp items in the appliance can cause wrinkling, colour transfer, and odour.

## Cleaning the Appliance Periodically

### Tub Clean

Use this function to clean inside of the appliance.

A higher water level is used in this programme at higher spin speed. Run this function once a month (or more often if needed) to remove detergent buildup and other residue.

- 1 Remove any clothing or items from the appliance and close the door.
- 2 Open the dispenser drawer and add anti-limescale powder to the main wash compartment.
  - Put tablets into the drum.
- 3 Close the dispenser drawer slowly.
- 4 Turn on the power, and then select the **Tub Clean**.
  - **tCL** will be displayed on the display.

- 5** Press the **Start/Pause** button to start.
- 6** After the programme is complete, leave the door open to dry the door opening, gasket, and door glass.

## CAUTION

- Leave the door open to dry the drum interior but only if it is safe and any children are supervised.

## Cleaning the Water Inlet Filter

Water inlet filter collects lime or any small objects that may be in water supplied to the appliance.

Clean the water inlet filter regularly.

### NOTE

- Turn off the supply tap to the appliance if the appliance is to be left for a certain period of time (e.g. holiday), especially if there is no floor drain (gully) in the immediate vicinity.
- iE message will be displayed on the control panel when the water is not entering the detergent drawer.
- If the water is very hard or contains traces of limescale, the filter on the water inlet may be clogged.

- 1** Turn off the water tap and unscrew the water inlet hose.

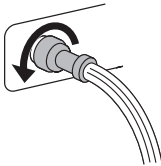

- 2** Clean the filter using a medium bristle tooth brush.

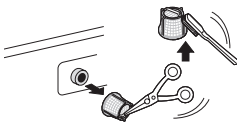

## Cleaning the Drain Pump Filter

The drain filter collects threads and small objects left in the laundry. Check regularly that the filter is clean to ensure smooth running of your appliance.

Allow the water to cool before cleaning the drain pump filter. Open the door in an emergency or perform a emergency evacuation.

- 1** Unplug the appliance.
- 2** Open the cover cap and pull out the hose.

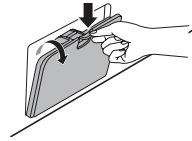

- 3** Unscrew the drain plug **1**, and then drain the water. Slowly unscrew the drain pump filter **2** to drain the water and remove small objects.

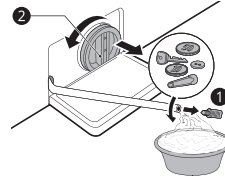

- 4 After cleaning the drain pump filter, take the drain pump filter out and insert the drain plug.
- 5 Close the cover cap.

## **!** CAUTION

- Be careful when draining, as the water may be hot.
- Run the drum cleaning programme once a month (or more often, as needed) to remove excess detergent and other debris.

- 3 To clean the drawer opening, use a cloth or small, non-metal brush to clean the recess.
  - Remove all residue from the upper and lower parts of the recess.
- 4 Wipe any moisture off the recess with a soft cloth or towel.
- 5 Re-assemble the components of the drawer to the proper compartments and insert the drawer.

## Cleaning the Dispenser Drawer

Detergent and fabric softener may build up in the dispenser drawer. Remove the drawer and the components of the drawer in the drawer and check for build-up of detergents or softeners once or twice a month.

- 1 Remove the detergent dispenser drawer by pulling the drawer straight out until the drawer stops.
  - Remove the drawer while pressing the disengage button.

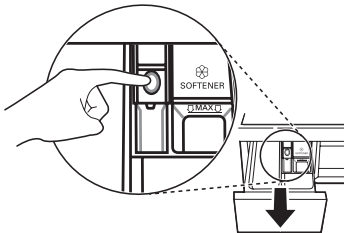

- 2 Remove the build-up of detergent and softener.
  - Rinse the drawer and the components of the drawer with warm water to remove the build-up from detergent and softener. Use only water to clean the dispenser drawer. Dry the drawer and the components of the drawer with a soft cloth or towel.

Operation of the appliance can lead to errors and malfunctions. The following tables contain possible causes and notes for resolving an error message or malfunction.

## Before Calling for Service

You can remedy most of the problems by yourself, consequently save time and money, since you do not need to call LG Electronics service centre. The following table should assist you by troubleshooting.

### Error Messages

The appliance is equipped with an automatic error-monitoring system to detect and diagnose problems at an early stage. If this appliance does not function properly or does not function at all, check the following before you call LG Electronics service centre.

| Symptoms                 | Possible Cause & Solution   |
|--------------------------|---|
| IE<br>INLET ERROR        | <b>Water supply is not adequate in that location. Water does not enter appliance or it enters slowly.</b> <ul style="list-style-type: none"> <li>Check another tap in the house.</li> </ul>   |
|                          | <b>Water supply tap is not completely open. Water does not enter the appliance or it enters slowly.</b> <ul style="list-style-type: none"> <li>Open fully tap.</li> </ul>   |
|                          | <b>Water supply hose(s) are kinked.</b> <ul style="list-style-type: none"> <li>Straighten hose or reinstall the water inlet hose</li> </ul>   |
|                          | <b>The filter of the supply hose(s) are clogged.</b> <ul style="list-style-type: none"> <li>Check and clean the filter of the inlet hose.</li> </ul>  |
|                          | <b>If water leakage occurs in the aqua stop supply hose, indicator will become red.</b> <ul style="list-style-type: none"> <li>Replace the aqua stop supply hose.</li> </ul>  |
| DE<br>WATER OUTLET ERROR | <b>Drain hose is kinked or clogged. Water in the appliance does not drain or drains slowly.</b> <ul style="list-style-type: none"> <li>Clean and straighten the drain hose.</li> </ul>  |
|                          | <b>The drain filter is clogged.</b> <ul style="list-style-type: none"> <li>Check and clean the drain filter.</li> </ul>   |
| UE<br>UNBALANCE ERROR    | <b>The appliance has a system which detects and corrects the unbalance of the appliance.</b> <ul style="list-style-type: none"> <li>The laundry may be too wet at the end of the cycle, rearrange the laundry to allow proper spinning. Close the door and press <b>Start/Pause</b> button. It may take a few moments before the appliance begins to spin. The door must be locked before spin can be achieved.</li> </ul>  |
|                          | <b>Load is too small. This system may stop spinning or even interrupt the spin cycle altogether if individual heavy articles (e.g. bath mat, bath robe, etc.) are loaded.</b> <ul style="list-style-type: none"> <li>Add 1 or 2 similar items or smaller articles of laundry to help balance the load. Close the door and press <b>Start/Pause</b> button. It may take a few moments before the appliance begins to spin. The door must be locked before spin can be achieved.</li> </ul> |

| Symptoms                            | Possible Cause & Solution  |
|-------------------------------------|--|
| dE dE1 dE2 dE4<br><b>DOOR ERROR</b> | <b>Door sensor malfunctions.</b> <ul style="list-style-type: none"> <li>• Please call LG Electronics service centre. You can find your local LG Electronics service centre phone number in the warranty card.</li> </ul>                     |
| tE<br><b>CONTROL ERROR</b>          | <b>This is a control error.</b> <ul style="list-style-type: none"> <li>• Unplug the power plug and call for service.</li> </ul>  |
| LE<br><b>MOTOR LOCKED ERROR</b>     | <b>Over load in motor</b> <ul style="list-style-type: none"> <li>• Let the appliance wait for 30 minutes until the motor is cooled down and then, restart the cycle.</li> </ul>  |
| FE<br><b>OVERFLOW ERROR</b>         | <b>Water overfills due to the faulty water valve.</b> <ul style="list-style-type: none"> <li>• Close the water tap.</li> <li>• Unplug the power plug.</li> <li>• Call for service.</li> </ul>  |
| PE<br><b>PRESSURE SENSOR ERROR</b>  | <b>Water level sensor malfunctions.</b> <ul style="list-style-type: none"> <li>• Close the water tap.</li> <li>• Unplug the power plug.</li> <li>• Call for service.</li> </ul>  |
| uS<br><b>VIBRATION SENSOR ERROR</b> | <b>Vibration sensor malfunctions.</b> <ul style="list-style-type: none"> <li>• Call for service.</li> </ul>  |
| FF<br><b>FROZEN FAILURE</b>         | <b>Is supply/drain hose or drain pump frozen?</b> <ul style="list-style-type: none"> <li>• Supply warm water into the drum in order to unfreeze the drain hose and the drain pump. Cover the supply hose with wet and warm towel.</li> </ul> |
| RE<br><b>WATER LEAKAGE</b>          | <b>Water leaks.</b> <ul style="list-style-type: none"> <li>• Call for service.</li> </ul>  |
| PF<br><b>POWER FAILURE</b>          | <b>The appliance experienced a power failure.</b> <ul style="list-style-type: none"> <li>• Restart the cycle.</li> </ul>   |
| dHE<br><b>DRY ERROR</b>             | <b>Does not dry.</b> <ul style="list-style-type: none"> <li>• Call for service.</li> </ul>   |

## Noises You Might Hear



| Symptoms                           | Possible Cause & Solution  |
|------------------------------------|--|
| <b>Rattling and clanking noise</b> | <b>Foreign objects, such as keys, coins, or safety pins may be in the drum.</b> <ul style="list-style-type: none"> <li>• Stop the appliance, check the drum for foreign objects. If the noise continues after the appliance is restarted, call for service.</li> </ul> |
| <b>Thumping sound</b>              | <b>Heavy wash loads may produce a thumping sound. This is usually normal.</b> <ul style="list-style-type: none"> <li>• If the sound continues, the appliance is probably out of balance. Stop and redistribute the wash load.</li> </ul>                               |

| Symptoms        | Possible Cause & Solution  |
|-----------------|--|
| Thumping sound  | <p><b>Wash load may be out of balance.</b></p> <ul style="list-style-type: none"> <li>• Pause the cycle and redistribute the load after the door unlocks.</li> </ul>   |
| Vibrating noise | <p><b>Package materials are not removed.</b></p> <ul style="list-style-type: none"> <li>• Remove package materials.</li> </ul>   |
|                 | <p><b>Wash load may be unevenly distributed in the drum.</b></p> <ul style="list-style-type: none"> <li>• Pause the cycle and redistribute the load after the door unlocks.</li> </ul>                                 |
|                 | <p><b>Not all levelling feet are resting firmly and evenly on the floor.</b></p> <ul style="list-style-type: none"> <li>• See the <b>Levelling the Appliance</b> to adjust the levelling of the appliance.</li> </ul>  |
|                 | <p><b>Floor not rigid enough.</b></p> <ul style="list-style-type: none"> <li>• Check if the floor is solid and does not flex. See the <b>Installation Place Requirements</b> to select the proper location.</li> </ul> |

## Operation

| Symptoms                    | Possible Cause & Solution  |
|-----------------------------|--|
| Water is leaking.           | <p><b>House drain pipes are clogged.</b></p> <ul style="list-style-type: none"> <li>• Unclog the drain pipe. Contact plumber if necessary.</li> </ul>  |
|                             | <p><b>Leakage is caused by improper installation of drain hose or clogged drain hose.</b></p> <ul style="list-style-type: none"> <li>• Clean and straighten the drain hose. Check and clean the drain filter regularly.</li> </ul>   |
| Appliance does not operate. | <p><b>Control panel has powered off due to inactivity.</b></p> <ul style="list-style-type: none"> <li>• This is normal. Press the <b>Power</b> button to turn the appliance on.</li> </ul>   |
|                             | <p><b>Appliance is unplugged.</b></p> <ul style="list-style-type: none"> <li>• Make sure that the cord should be plugged securely into a working outlet.</li> </ul>  |
|                             | <p><b>Water supply is turned off.</b></p> <ul style="list-style-type: none"> <li>• Turn the water supply tap completely.</li> </ul>  |
|                             | <p><b>Controls are not set properly.</b></p> <ul style="list-style-type: none"> <li>• Make sure that the cycle should be correctly set. Close the door and press the <b>Start/Pause</b> button.</li> </ul>   |
|                             | <p><b>Door is open.</b></p> <ul style="list-style-type: none"> <li>• Close the door and make sure that nothing should be caught under the door preventing it from closing completely.</li> </ul>   |
|                             | <p><b>Circuit breaker/fuse is tripped/blown.</b></p> <ul style="list-style-type: none"> <li>• Check house circuit breakers/fuses. Replace fuses or reset breaker. The appliance should be on a dedicated branch circuit. The appliance will resume the cycle where it stopped once power is restored.</li> </ul> |



| Symptoms   | Possible Cause & Solution   |
|--|---|
| Appliance does not operate.                                      | <b>Control needs to be reset.</b> <ul style="list-style-type: none"> <li>Press the <b>Power</b> button, then reselect the desired programme and press the <b>Start/Pause</b> button.</li> </ul>   |
|  | <b>Start/Pause was not pressed after a cycle was set.</b> <ul style="list-style-type: none"> <li>Press the <b>Power</b> button, then reselect the desired programme and press the <b>Start/Pause</b> button. The appliance is turned off if the <b>Start/Pause</b> button is not pressed within 15 minutes.</li> </ul>  |
|  | <b>Extremely low water pressure.</b> <ul style="list-style-type: none"> <li>Check another tap in the house to make sure that household water pressure should be adequate.</li> </ul>  |
|  | <b>Appliance is heating the water or making steam.</b> <ul style="list-style-type: none"> <li>The drum may stop operating temporarily during certain cycles, while water is safely heated to a set temperature.</li> </ul>  |
| Buttons may not function properly.                               | <b>The door cannot be opened for safety reasons once the appliance starts.</b> <ul style="list-style-type: none"> <li>Check if the  is illuminated. You can safely open the door after the <b>Door Lock</b> icon turns off.</li> </ul>   |
| Door does not open.  | <b>The door cannot be opened for safety reasons once the appliance starts.</b> <ul style="list-style-type: none"> <li>Check if the  icon is illuminated. You can safely open the door after the  icon turns off.</li> </ul> |
| Appliance is not filling properly.                               | <b>Filter clogged.</b> <ul style="list-style-type: none"> <li>Make sure the inlet filters on the fill valves are not clogged.</li> </ul>  |
|  | <b>Inlet hoses may be kinked.</b> <ul style="list-style-type: none"> <li>Check that inlet hoses are not kinked or clogged.</li> </ul>   |
|  | <b>Insufficient water supply.</b> <ul style="list-style-type: none"> <li>Make sure that both hot and cold water taps should be turned on all the way.</li> </ul>  |
|  | <b>Hot and cold inlet hoses are reversed.</b> <ul style="list-style-type: none"> <li>Check inlet hose connections.</li> </ul>   |
| Appliance does not drain water.                                  | <b>Kinked drain hose.</b> <ul style="list-style-type: none"> <li>Ensure that the drain hose is not kinked.</li> </ul>   |
|  | <b>Drain located higher than 1.2 m above the floor.</b> <ul style="list-style-type: none"> <li>Make sure that the drain hose should not be higher than 1.2 m above the bottom of the appliance.</li> </ul>  |
| Detergent is not dispensed incompletely or not dispensed at all. | <b>Too much detergent is used.</b> <ul style="list-style-type: none"> <li>Follow the guidelines provided by the detergent manufacturer.</li> </ul>  |
| Cycle time is longer than usual.                                 | <b>The load is too small.</b> <ul style="list-style-type: none"> <li>Add more items to allow the appliance to balance the loads.</li> </ul>   |

| Symptoms                         | Possible Cause & Solution   |
|----------------------------------|---|
| Cycle time is longer than usual. | <b>Heavy articles are mixed with lighter items.</b> <ul style="list-style-type: none"> <li>Always try to wash articles with similar weight in order to allow the appliance to evenly distribute the weight of the load for spinning.</li> </ul> |
|                                  | <b>The load is out of balance.</b> <ul style="list-style-type: none"> <li>Manually redistribute the load if articles have become tangled.</li> </ul>  |
| Duration is delayed              | <b>Unbalance is detected or suds removing programme is on.</b> <ul style="list-style-type: none"> <li>This is normal. The time remaining shown on the display is only an estimated duration. Actual time may vary.</li> </ul>                   |

## Drying

| Symptoms  | Possible Cause & Solution  |
|---|--|
| Dry problem   | <b>Check water supply tap.</b> <ul style="list-style-type: none"> <li>Do not overload. Check that the washing machine is draining properly to extract adequate water from the load. When load of laundry is too small to tumble properly. Add a few towels.</li> <li>Turn off water supply tap.</li> </ul> |
| Drying performance is too low or bad.                     | <b>Water is not properly supplied. The water is used for auto-cleaning of lint-filter on drum during the drying.</b> <ul style="list-style-type: none"> <li>Make sure the water supply tap is open.</li> </ul>   |
|   | <b>Water does not properly drain.</b> <ul style="list-style-type: none"> <li>Make sure the drain filter is not clogged.</li> </ul>   |
|   | <b>The appliance is overloaded.</b> <ul style="list-style-type: none"> <li>Check the load capacity for the selected cycle. If necessary, add a time dry cycle.</li> </ul>  |
|   | <b>The spin speed is too low.</b> <ul style="list-style-type: none"> <li>Select the highest spin speed allowed for the wash cycle.</li> </ul>  |
| Drying time is too long.                                  | <b>The ambient temperature is low.</b> <ul style="list-style-type: none"> <li>Make sure the temperature is allowable range.</li> </ul>   |
| A warm air comes out from the rear side of the appliance. | <b>This appliance makes a warm air to dry the laundry.</b> <ul style="list-style-type: none"> <li>This warm air dries the laundry and comes out from the rear side of the appliance.</li> </ul>  |

## Performance

| Symptoms                            | Possible Cause & Solution   |
|-------------------------------------|---|
| Poor stain removal                  | <p><b>Previously set stains.</b></p> <ul style="list-style-type: none"> <li>Articles that have been previously washed may have stains which have been set. These stains may be difficult to remove and may require hand washing or pre-treating to aid in stain removal.</li> </ul>               |
| Staining                            | <p><b>Bleach or softener is dispensed too soon.</b></p> <ul style="list-style-type: none"> <li>Dispenser compartment is overfilled. It makes bleach or softer dispensed rapidly. Always measure bleach or softener to prevent overfilling.</li> <li>Close the dispenser drawer slowly.</li> </ul> |
|                                     | <p><b>Bleach or softener was added directly to the wash load in the drum.</b></p> <ul style="list-style-type: none"> <li>Always use the dispensers to ensure that laundry products are properly dispensed at the right time in the cycle.</li> </ul>  |
|                                     | <p><b>Clothes were not properly sorted.</b></p> <ul style="list-style-type: none"> <li>Always wash dark colours separately from light colours and whites to prevent discolouration.</li> <li>Never wash heavily soiled items with lightly soiled items.</li> </ul>                                |
| Wrinkling                           | <p><b>Appliance is not unloaded promptly.</b></p> <ul style="list-style-type: none"> <li>Always remove items from the appliance as soon as the cycle is complete.</li> </ul>  |
|                                     | <p><b>Appliance is overloaded.</b></p> <ul style="list-style-type: none"> <li>The appliance can be fully loaded, but the drum should not be tightly packed with items. The door of the appliance should be closed easily.</li> </ul>  |
|                                     | <p><b>Hot and cold water inlet hoses are reversed.</b></p> <ul style="list-style-type: none"> <li>Hot water rinse can set wrinkles in garments. Check the inlet hose connections.</li> </ul>  |
| Musty or mildewy odour in appliance | <p><b>Inside of drum is not cleaned properly.</b></p> <ul style="list-style-type: none"> <li>Run the <b>Tub Clean</b> function regularly.</li> </ul>  |
|                                     | <p><b>The drain hose is not properly installed, causing siphoning (water flowing back inside of the appliance).</b></p> <ul style="list-style-type: none"> <li>When installing the drain hose, make sure that it does not get kinked or blocked.</li> </ul>                                       |
|                                     | <p><b>The detergent dispenser drawer is not cleaned regularly.</b></p> <ul style="list-style-type: none"> <li>Clean the detergent dispenser drawer, especially the top and the bottom of the drawer's opening.</li> </ul>   |
|                                     | <p><b>Odours can occur if the drain hose is not properly installed, causing siphoning (water flowing back inside of the appliance).</b></p> <ul style="list-style-type: none"> <li>When installing the drain hose, make sure that it does not get kinked or blocked.</li> </ul>                   |
|                                     | <p><b>If the detergent dispenser drawer is not cleaned regularly, odours can occur from mold or foreign substances.</b></p> <ul style="list-style-type: none"> <li>Clean the detergent dispenser drawer, especially the top and bottom of the drawer's opening.</li> </ul>                        |

## Wi-Fi

| Symptoms   | Possible Cause & Solution  |
|--|--|
| <p><b>Your home appliance and smart phone is not connected to the Wi-Fi network.</b></p> | <p><b>The password for the Wi-Fi that you are trying to connect to is incorrect.</b></p> <ul style="list-style-type: none"> <li>Find the Wi-Fi network connected to your smartphone and remove it, then register your appliance on <b>LG SmartThinQ</b>.</li> </ul>  |
|  | <p><b>Mobile data for your smartphone is turned on.</b></p> <ul style="list-style-type: none"> <li>Turn off the Mobile data of your smartphone and register the appliance using the Wi-Fi network.</li> </ul>  |
|  | <p><b>The wireless network name (SSID) is set incorrectly.</b></p> <ul style="list-style-type: none"> <li>The wireless network name (SSID) should be a combination of English letters and numbers. (Do not use special characters).</li> </ul>   |
|  | <p><b>The router frequency is not 2.4 GHz.</b></p> <ul style="list-style-type: none"> <li>Only a 2.4 GHz router frequency is supported. Set the wireless router to 2.4 GHz and connect the appliance to the wireless router. To check the router frequency, check with your internet service provider or the router manufacturer.</li> </ul>     |
|  | <p><b>The distance between the appliance and the router is too far.</b></p> <ul style="list-style-type: none"> <li>If the distance between the appliance and the router is too far, the signal may be weak and the connection may not be configured correctly. Move the location of the router so that it is closer to the appliance.</li> </ul> |

## Product Fiche

### Commission Directiv (EU) No 96/60/EC

| Supplier's name or trade mark   | LG           |                                      |   |
|---|--------------|--------------------------------------|---|
| Supplier's model  |              | FVV917WTS<br>V9WD107H2S<br>F4DV910H2 | V9WD96H2<br>V9WD960<br>F4DV909H2<br>FWV996WTS |
| Energy efficiency class <sup>*1</sup>   |              | A                                    | A   |
| Energy consumption for washing, spinning and drying <sup>*2</sup>   | kWh/cycle    | 7.14                                 | 6.12  |
| Energy consumption for washing and spinning only <sup>*3</sup>  | kWh/cycle    | 1.37                                 | 1.52  |
| Washing performance class <sup>*4</sup>   |              | A                                    | A   |
| Water extraction efficiency <sup>*5</sup>   |              | A                                    | A   |
| Water remaining after spin (as a proportion of dry weight of wash)  | %            | 44                                   | 44  |
| Maximum spin speed <sup>*6</sup>  | rpm          | 1370                                 | 1370  |
| Rated capacity  |              |                                      |   |
| Washing capacity  | kg           | 10.5                                 | 9   |
| Drying capacity <sup>*8</sup>   | kg           | 7                                    | 6   |
| Water consumption for washing, spinning and drying <sup>*9</sup>  | litres/cycle | 180                                  | 165   |
| Water consumption for washing and spinning only <sup>*10</sup>  | litres/cycle | 70                                   | 62  |
| Washing and drying time <sup>*11</sup>  | min.         | 789                                  | 660   |
| Estimated annual energy and water consumption for a four-person household, always using the drier (200 cycles) <sup>*12</sup> | kWh/year     | 1428                                 | 1224  |
|   | litres/year  | 36000                                | 33000   |
| Estimated annual energy and water consumption for a four-person household, never using the drier (200 cycles) <sup>*12</sup>  | kWh/year     | 274                                  | 304   |
|   | litres/year  | 14000                                | 12400   |
| Noise during washing, spinning and drying phases using standard 60° C cotton washing cycle and 'dry cotton' drying cycle.     | dB(A)        | 48                                   | 48  |
|   | dB(A)        | 71                                   | 71  |
|   | dB(A)        | 54                                   | 54  |

\*1: Energy efficiency class scale is from A (more efficient) to G (less efficient).

\*2: For washing, spinning, and drying, in kWh per complete operating cycle.

\*3: For washing and spinning only, in kWh per washing cycle.

- \*4: Washing performance class scale is from A (higher) to G (lower).
- \*5: Water remaining after spin after standard 60 °C cotton washing cycle (as proportion of dry weight of the wash)
- \*6: Attained for the standard 60 °C cotton washing cycle
- \*7: Of appliance for a standard 60 °C cotton washing cycle.
- \*8: Of appliance for a standard 'dry cotton' drying cycle.
- \*9: In liters, using standard 60° C cotton washing cycle and 'dry cotton' drying cycle
- \*10: In litres, using standard 60° C cotton washing (and spinning) cycle
- \*11: Programme time for complete operating cycle (60 °C cotton washing and 'dry cotton' drying)
- \*12: The consumption of energy and water equal to 200 cycles consumption

# Memo



**For U.K. Customer**

CUSTOMER SERVICES Tel. : UK: 0344 847 5454/  
IE: 01 686 9454  
LGEUK SERVICE WEB-SITE : [www.lg.com/uk](http://www.lg.com/uk)