

### 6.3 Maintenance

#### (a) Cleaning the Handset:

To get the best performance from your shower, the plate in the handset must be cleaned regularly, maybe as often as once a week in hard water areas.

This is because the fine outlet holes can become restricted with scale, and this will affect the pattern of the spray and cause the heater to perform poorly.

The handset with rubber spray outlets can

be cleaned simply by rubbing one's hand over them firmly to dislodge scale.

Some handsets are supplied with their own special 'spanner key' to remove the spray plate for cleaning. Follow the directions below for your particular handset.

#### (b) Inspection:

We recommend that in the interests of safety the shower and its electrical installation is checked by a qualified electrician at least every two years.

	To open, turn anti-clockwise either by hand or using the spanner key where supplied.	Scrub the spray cartridge with a small, stiff brush to remove stubborn scale deposits. Ensure rubber 'O' rings are replaced when cleaning is complete (not all models).	When scale has been removed, rinse in clean water. Re-assemble handset together turning spray plate clockwise, ready for use.
<b>Standard Handset 1</b>			
<b>Standard Handset 2</b>			
<b>Multi-mode Handset 3</b>			
<b>Multi-mode Handset 4</b>			
<b>Standard Handset 5</b>			

If you need to replace your handset, please contact our Spares Department.

Gainsborough

# Energy 1000x

## Instant Electric Shower

BACK BATHROOM

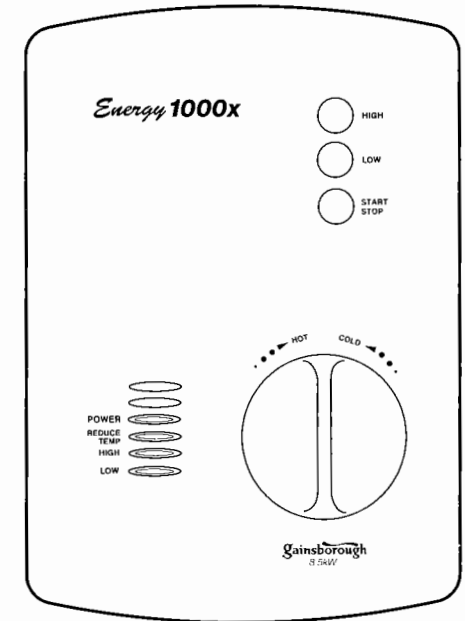

### A Step by Step Guide to Installing and Using your Shower

Gainsborough Showers, Fifers Lane,  
Norwich, Norfolk NR6 6XB  
Telephone: 01603 787171

Please leave with the user

Please read and understand these instructions before starting work

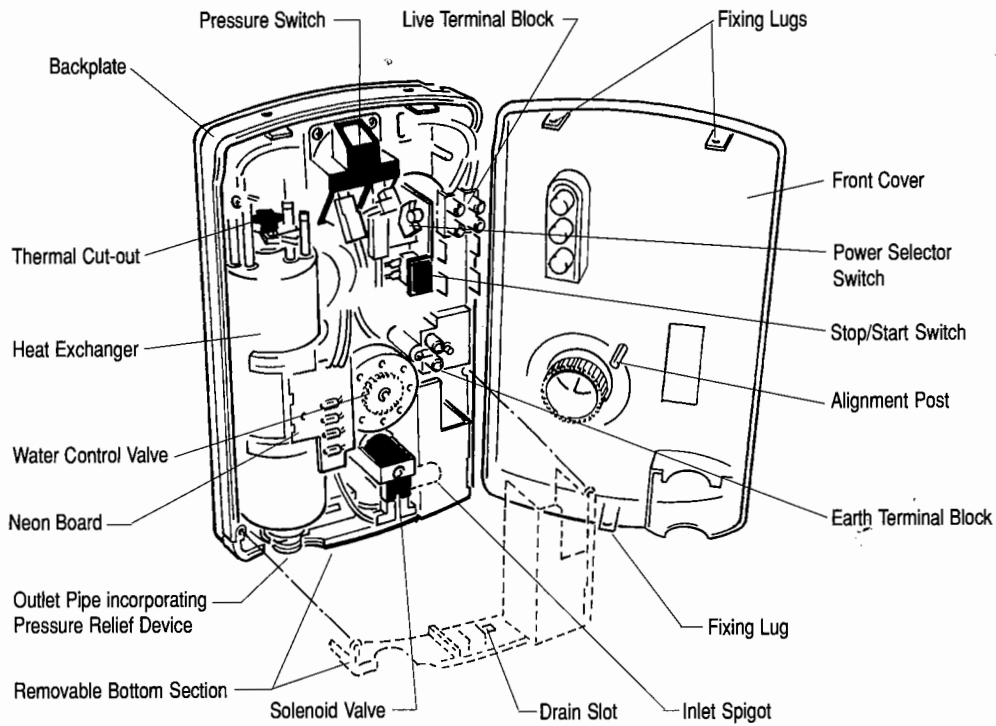

**Figure 1.0** Major Internal Components

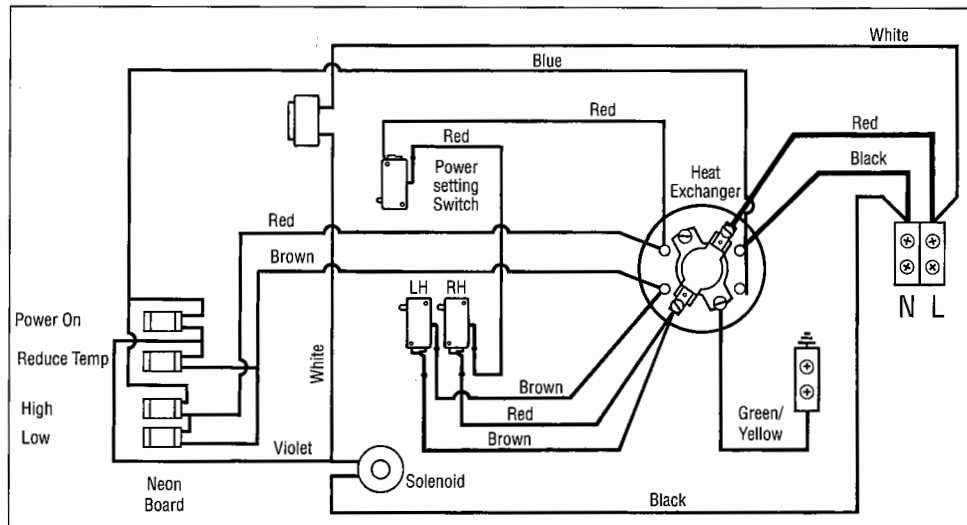

**Figure 1.1** Internal Circuit Diagram

## CONTENTS

		Page
<b>YOUR SHOWER</b>	Recognition of major components Circuit Diagram	2
<b>SECTION ONE</b>	Important information for installers and users How an instantaneous shower works	4 5
<b>SECTION TWO</b>	Siting and Plumbing	6 – 7
<b>SECTION THREE</b>	Electrical Installation	8 – 9
<b>SECTION FOUR</b>	Connecting the shower to services	10 – 15
<b>SECTION FIVE</b>	Fault-Finding	16 – 18
<b>SECTION SIX</b>	User Instructions	19 – 20

NB Due to product variations the precise appearance of your shower may not be exactly as depicted in this leaflet. Dimensions and functioning are unaffected.

# SECTION ONE

## Important Information

Your shower is designed and tested to the very highest standards and complies fully with all of the relevant national/international standards for safety and reliability. The shower is manufactured in a BS EN ISO 9002-registered factory – your assurance of a quality product.

To ensure correct use and maintenance of the shower, please read and adhere to the following warnings and guidelines.

### For Installers:

**1.1** Do not attempt any of the electrical or plumbing work necessary to install this product unless you have good practical experience and adequate understanding of the IEE Wiring Regulations and Water By-Laws.

**1.2 WARNING: THIS APPLIANCE MUST BE EARTHED.**

**1.3** Before removing your shower heater cover always ensure your shower heater is isolated from the electrical mains.

**1.4** This product is splash-proof, and is approved for use in shower cubicles and over baths. However, do not install the shower heater in a position where the handset, in its normally-parked position, will consistently direct spray over it.

**1.5a** We strongly recommend that you fit an isolating valve in the pipework to the shower, in an accessible place. This will be of great benefit if any maintenance work, or complete replacement of the shower, is required later on.

**1.5b** This shower is designed for domestic use and is not vandal-resistant. If it is installed in an institutional or commercial situation, frequent inspection may be necessary, and our guarantee may be affected.

### For Users:

**1.5** If water emerges from anywhere other than the spray head outlets, do not use your shower, and refer to the fault-finding section.

**1.6 IT IS IMPORTANT TO CLEAN THE HANDSET SPRAY PLATE REGULARLY**, particularly in hard water areas, where this may be necessary as often as once a week. Failure to do so will affect the performance of the shower, and in extreme cases may cause the pressure relief device to operate.

Refer to Section 6.

**1.7 The shower heater outlet, hose and handset act as a vent. They must not be blocked, obstructed, or have connected to them any fitting not approved by us.** The use of unapproved accessories may invalidate the guarantee and affect the performance and safety of the unit.

**1.8 WARNING: DO NOT USE** the shower if the HOSE IS DAMAGED in any way; for instance if the outer covering has parted to reveal the inner tube. A damaged hose can suddenly restrict the flow and result in extremely hot water from the spray head. A damaged hose could completely block the outlet of the shower; the resulting increase in pressure could burst a weakened or damaged hose.

**1.9** Do not install the shower in a situation where the water in it could freeze. Any damage caused by freezing will not be covered by the guarantee.

**If you suspect your shower is frozen, SWITCH OFF IMMEDIATELY.** Refer to Fault-Finding, Section Five.

**1.10** Do not leave young children, the infirm or the disabled unattended in the shower.

**1.11** Before stepping into the shower, always test the temperature of the spray with your hand.

**1.12** Switch off at the isolating switch after use. This is a safety procedure recommended with ALL electric appliances.

**1.13** As with all electrical appliances, it is recommended to have your shower and installation checked at least every two years by a competent electrician, to ensure there is no deterioration due to age and usage.

**1.14** Shampoo and shower gel should be stored using the gel hook and soap dish (where provided) and **must not be placed on top of the shower unit.**

### How an instant electric shower works

**1.15** In an instant electric shower, an electric element heats water AS IT PASSES THROUGH. The temperature of the shower is adjusted by controlling the rate at which water flows over the heating element. This is done using a flow control knob. There is no thermostat. If the temperature of the incoming water varies (mains water can be as low as 5° C in the winter and as high as 20° C in summer), the output temperature will also vary. The shower is only able to RAISE the temperature of the water by a given amount (depending upon the flow rate).

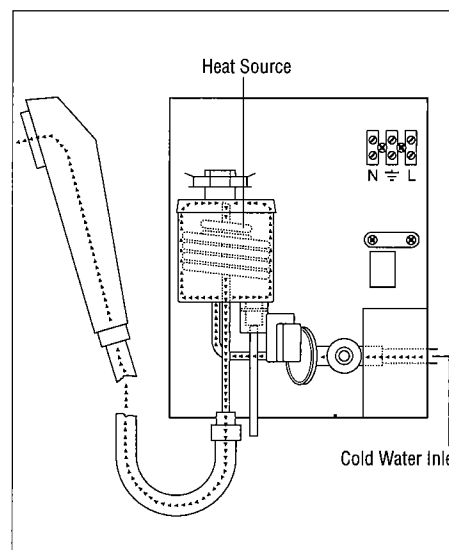

**Figure 1.15** Showing how the water is heated as it passes through.

## SECTION TWO

### Siting and Plumbing

Spend some time planning exactly where to site the shower heater and riser rail. Bear in mind the height of people who will be using it.

#### Tools you may need:

- Adjustable spanner giving at least 25 A/F
- Flat blade screwdriver with blade width 5-6mm
- No 2 Pozidriv screwdriver with a bit in good condition
- Sharp Stanley knife
- Round file
- Pipe cutters
- Electric drill and 7mm dia (N° 14) masonry bit
- Wire cutters
- Electrician's insulation strippers

#### Other items you may need:

- 15mm compression elbow or straight connector for connection to the shower unit
- 15mm isolating valve

#### Things you must do:

**2.1** It is advisable to check that the water pressure to the shower is adequate. If in doubt, consult a competent plumber.

Max: 10 bar.

Min: Up to and including 9.5kW: 0.9 bar.

Over 9.5kW: 1.1 bar.

The minimum figures are **running** pressures with at least 5 l/min flowing.

The use of other services connected to the water pipe supplying the shower heater may cause the water pressure to drop below the minimum.

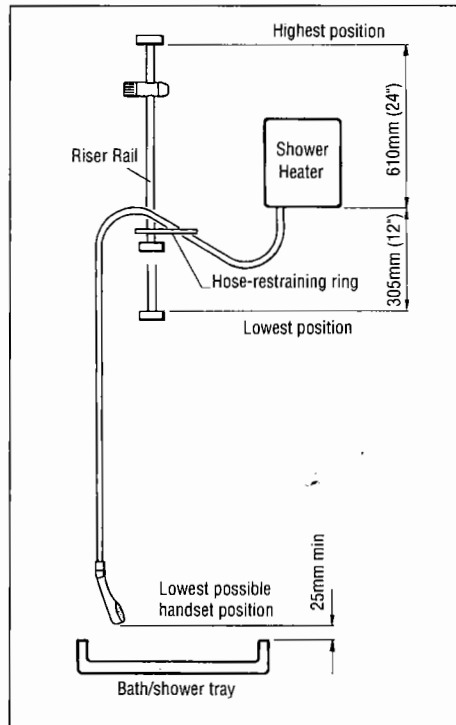

**Figure 2.6** Siting of riser rail and heater

The following conversions may be useful:

$$\begin{aligned} 1 \text{ bar} &= 14.5 \text{ lbf/in}^2 \\ &= 33.3 \text{ ft head of water} \\ &= 10 \text{ m head of water.} \end{aligned}$$

$$1 \text{ lbf/in}^2 = 2.3 \text{ ft head.}$$

**2.2** Electric shower heaters are normally plumbed into the mains water (except for special low pressure versions). However, the shower heater may be fed from a storage tank as long as there is a sufficient head of water.

**2.3** Mount the shower heater on a flat vertical wall with the outlet, to which the hose is connected, pointing downwards.

**2.4** Ensure that the shower heater is not in the direct spray of a normally parked handset.

**2.5** Allow room around the shower heater for removal of the front cover.

**2.6** Position the riser rail close to the heater, not necessarily on the same wall (but bear in mind paragraph 2.4) so that, in its highest parked position the handset is no more than 610mm (24") above the bottom of the heater, and in its lowest position it is no lower than 305mm (12") below the heater (see Fig. 2.6).

**2.7** Remember that if the handset can reach to within 25mm (1") of the spillover level of the bath, shower tray, wash basin, WC or bidet, then to prevent the possibility of back-siphonage of used water, (Water Bye-Law 17) you must either:

- install a hose-restraining ring (see Fig. 2.6).
- fit a combined vacuum breaker-and-check valve unit between the hose and shower heater.
- fit a double-check valve in the pipework to the shower.

**2.8** Decide from which direction your pipe will enter the shower heater. There is a choice of top, bottom, rear or side. See Section Four for details.

**2.9** Ensure there are no services such as gas, water pipes, electrical or telephone cables beneath the surface of the wall before drilling. Special handheld testers are available from hardware stores.

**2.10** The water connection to the shower heater should be made using standard 15mm outside diameter copper pipe or

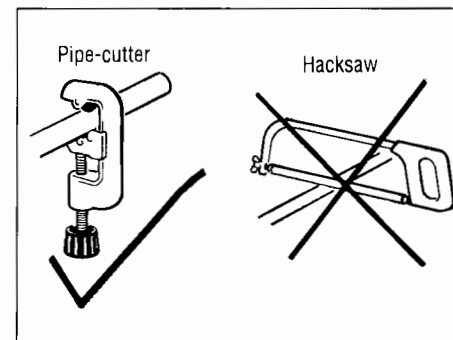

**Figure 2.10**

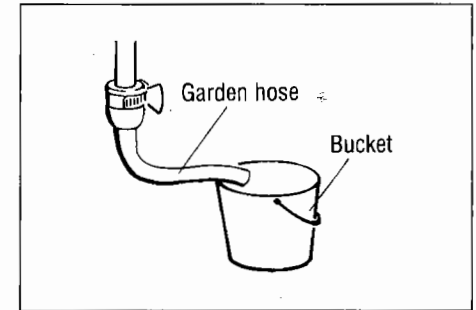

**Figure 2.11**

stainless steel pipe. The ends should be cut square and be free from internal and external burrs and deep scratches. Where possible, use a pipecutter and not a saw, to prevent saw chippings entering the pipe.

**2.11** Before making the final water connections to the shower heater, the pipework **MUST BE FLUSHED THOROUGHLY** to remove brick dust, swarf etc. which could severely damage the shower itself (See Fig. 2.11).

**2.12** It is recommended that a Water Research Council-listed servicing valve is fitted in the water supply pipe to the shower. This is to allow the shower heater to be serviced without turning off the water supply to other appliances.

#### Things you must not do:

**2.13** Do not use plumber's paste on any joints as this may damage the shower.

**2.14** Do not use a blow-torch or other form of heat close to the shower heater as this may damage the non-metallic parts.

**2.15** Do not use excessive force, and do ensure adequate support, when making connections.

# SECTION THREE

## Electrical Installation

### WARNING:

THIS APPLIANCE MUST BE EARTHED

The electrical installation should be carried out in accordance with the IEE Wiring Regulations.

The following notes are for guidance only:

**3.1** The shower heater must only be connected to a 230/240V ac supply. If you are either:

- installing a 10.8kW shower or
  - installing the shower in a rural location
- it is a good idea to advise the Regional Electricity Company.

Please note that if a cable is operated at or near its maximum rating for a given installation method, it may feel very warm. This is normal and will not result in deterioration of the cable insulation.

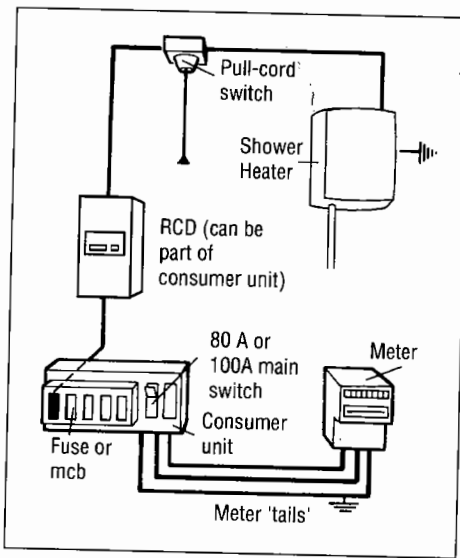

**Figure 3.3** Schematic diagram of straightforward installation circuit

### 3.2 Before making any electrical connections within the installation, make sure that no terminal is live.

If in doubt, switch off the whole installation at the consumer unit or switch fuse (where fitted).

**3.3** The shower heater must be connected to its own independent electrical circuit. It **MUST NOT** be connected to a ring main, spur, socket outlet, or lighting circuit, otherwise the circuit will overheat.

**3.4** Check that your consumer unit (main fuse box):

- has a main switch rating of 80A or above and
- has a spare fuse way which will take the fuse/mcb you need to fit (See Figs. 3.9 and 3.10).

If so, you can wire the shower direct to the spare fuseway of your consumer unit (See Fig. 3.3). NB Not all consumer units accept a 35/40/45A sized fuse.

**3.5** If 3.4 (i) or (ii) are not so, the installation is not straightforward, since it could involve installing a new consumer unit to serve the whole house or just the shower. You will need to call in your Regional Electricity Company to check the circuit and make the connections to the meter or service connector block. They will also check the bonding of items in the bathroom.

**3.6** All exposed metallic parts in the bathroom must be bonded together using cable of at least 4mm<sup>2</sup> CSA (cross sectional area). These parts include metal baths, radiators, water pipes (including the feed to the shower), taps and waste fittings.

**3.7** For all installation arrangements work back from the shower to the consumer unit. Before making the final connections, check the circuit for continuity and insulation resistance.

**3.8** It is recommended that a residual current device (rcd), formerly known as an earth leakage circuit breaker (elcb), with a

tripping current of 30mA, is incorporated in the circuit. This removes the need to check your earth loop impedance.

**3.9** A double-pole isolating switch, with a contact separation of at least 3mm in each pole, must be incorporated in the circuit. This must have a mechanical indicator showing when the switch is in the OFF position. A neon lamp alone is not sufficient. (See Fig. 3.9 for minimum switch rating.) If it is fitted in the bathroom it must be of the cord-operated type. It should be placed so that it is:

- Not possible to touch the switch body when standing in the bath or shower cubicle.
- Preferably outside the shower enclosure.
- Readily accessible (you should switch off after using the shower).

### 3.10 Choosing cable and fuse sizes

Refer to Fig. 3.9 to determine the nominal current of your shower.

The current rating of your cable must be at least that of the shower itself. Then use Fig. 3.10 to choose a fuse or mcb with a rating less than that of your chosen cable. We advise against using rewirable fuses.

If the cable is to be:

- bunched with others
- in an ambient of above 40°C
- in an insulating wall or within thermal insulation, e.g. loft insulation
- any other unusual situation

the current rating will be reduced.

IF IN DOUBT **ALWAYS** SEEK ADVICE FROM A COMPETENT ELECTRICIAN.

Product Rating at 240V (kW)	Nominal Current at 240V (amps)	Min Rating of Isolating Switch at 240V (amps)	Recommended Max Cable Length (metres)		
			4mm <sup>2</sup> Cable	6mm <sup>2</sup> Cable	10mm <sup>2</sup> Cable
7	29	30	18	28	47
7.2	30	30	18	27	45
8	33.5	35	16	24	40
8.5	35.5	40	15	23	38
9	37.5	40	N/A	22	36
9.5	39.5	40	N/A	21	34
10.8	45	45	N/A	18	30

**Figure 3.9** Rating of showers, switch and maximum cable runs.

PVC Twin and Earth Cable	Cable Installation Method	4mm <sup>2</sup>			6mm <sup>2</sup>			10mm <sup>2</sup>		
		Current Rating	Suitable:		Current Rating	Suitable:		Current Rating	Suitable:	
			Fuse	MCB		Fuse	MCB		Fuse	MCB
	Direct in plaster or clipped to vertical wall	36	30,35	30,32	46	40, 45	40, 45	63	45	45, 50
	In conduit or trunking, within or on the surface of a brick wall	30	30	30	38	35	30, 32	52	40, 45	40, 45, 50

**Figure 3.10** Cable rating, and suitable cartridge fuses/mcb's (rewirable fuses are not recommended and are not covered by this table). NB Fuses with ratings above 45A are not generally available. Values are in amps.

# SECTION FOUR

## Connecting the Shower to Services

### PREPARATION:

**4.1** Remove the fixing screws which hold the front cover to the backplate. Note that the upper screws are different from the lower one.

**4.2** Carefully remove the cover, which holds both control knobs captive, by pulling directly away from the backplate. Do not twist, otherwise you may snap the fixing lugs on the front cover.

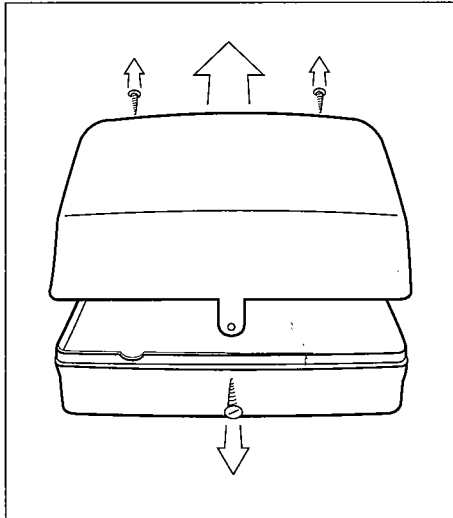

**Figure 4.2**

**4.3** Carefully take out the removable bottom section of the backplate by lifting its sockets clear of the pegs on the backplate (See Fig. 1.0). This section allows greater access for installing the cable and pipe. Keep it safe, as it could easily be damaged.

**4.4** Decide which entry points you will use for cable and water pipe (See Fig. 4.8).

**4.5** Decide where to mount the shower. Refer to Section Two for guidance. Ensure that you leave enough room around the shower for removal of the front cover for inspection or servicing at a later date.

**4.6** It is best to mount the shower on top of any tiling, so that it can be replaced easily in the future without requiring re-tiling. If you must tile around the shower, DO NOT grout right up to the shower backplate as this makes subsequent removal difficult. Do not seal the shower to the wall using bath sealant, as the shower will not be harmed by water dripping behind it.

**4.7** Remove the relevant areas of the backplate, which are not knockouts, using a sharp knife and/or a round file.

### Cable and Pipe Entries:

#### Cable Entry

**4.8 Available entry points:** Top, bottom and rear (rear is generally the easiest). Side entry is not possible. The thinned areas in the backplate and bottom section are suitable for a cable size up to 16mm<sup>2</sup>.

For rear entry, cable must emerge from the wall only in the areas specified in Fig. 4.8. You will need at least 280mm of cable to emerge from the wall to allow connection to the terminal block.

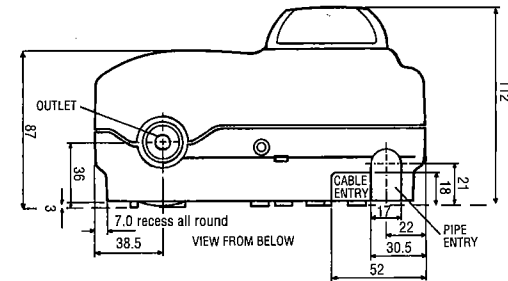
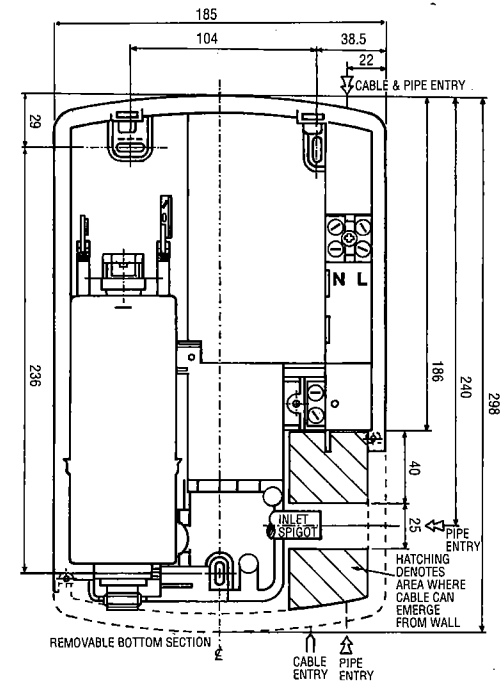

**Figure 4.8** Backplate dimensions (in mm)

#### Pipe Entry

**Available entry points:** Top, bottom, rear and right hand side (bottom is generally the easiest). The inlet spigot is smooth, 15mm diameter and is designed to accept a 15mm compression fitting. This must be an elbow for top, bottom and rear entry, and a straight connector for side entry. You should use compression rings (olives) made of copper, rather than brass, as copper will crush down better onto the plastic spigot. Push-fit connectors cannot be used.

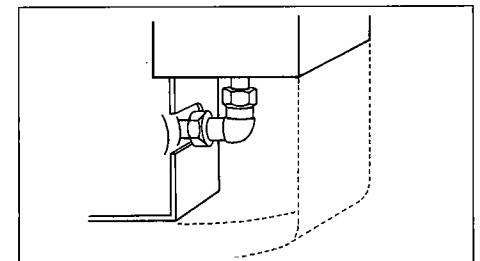

**Figure 4.10** Connection of pipe to inlet (top entry shown)

## Rear Entry

If the pipework is to enter from the rear, you must cut away the wall from around the pipe to allow room for the nut on the compression elbow to be recessed into the wall (See Fig. 4.11). The pipework MUST be connected to the elbow BEFORE the shower is fitted to the wall; if you were to fix the pipe in place first, you would not be able to get a spanner onto the compression nut.

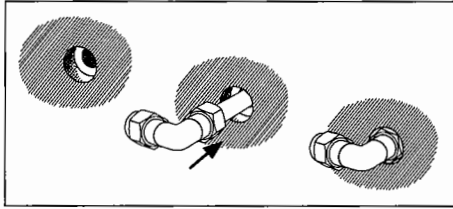

Figure 4.11

Depending on the type of compression elbow used, you may need to remove a small part of the bottom section of the backplate in order for it to fit over the elbow nut.

## Top Entry

You must connect the ELBOW to the INLET SPIGOT first; if you were to connect the elbow to the pipe first, there would not be enough room within the pipe channel in the shower to manoeuvre the elbow onto the spigot.

## Side Entry

You must use a straight connector with an overall length (including nuts and olives) of less than 42mm.

## Plumbing:

**4.13** Decide where to connect to the water mains for your feed to the shower. Ensure that the pipe you have selected is not a gas pipe (they can look similar) or a hot water pipe, nor from a cold water storage tank (unless you have sufficient head – see Section 2.2).

**4.14** Cut the necessary pipework to length, assemble and offer up to the installation before making any soldered joints. Ensure that the pipe is the correct length, since to shorten it can be difficult once joints have been made.

**4.15** Carry out any cutting with pipe cutters in preference to a hacksaw, to minimise swarf. Use 15mm compression fittings, preferably with copper compression rings (olives), for the connection to the shower heater.

**4.16** Remember to incorporate a servicing valve and, if required, a double-check valve (see Section 2.7).

**4.17** Locate your stop cock, and turn off the water supply. Check that the pipe you intend tapping off no longer carries water, by opening a tap that the pipe supplies.

**4.18** Make your connection to the pipe. If it is on a low-lying loop there may be some water left in the pipe, so be prepared for some flow of water. Make all joints except that to the shower heater before flushing.

**4.19 It is essential to flush the system in order to clear any debris, bits of solder and swarf which could enter and damage components within the shower heater**

(See Fig. 2.11). It may be best to take the shower off the wall to do this.

**4.20** Turn the water off after flushing, either at the stop cock or by using your servicing valve.

**4.21** Remount the shower firmly and make the final water connection to it. Turn the water on again.

**4.22** No water will flow from the shower outlet until the electricians are connected, as the shower incorporates a solenoid valve.

**4.23** Check for leaks in all pipework, and rectify as necessary.

## Fitting the Riser Rail and Accessories:

**4.24** Remove the covers from the two end brackets.

**4.25** Assemble the riser rail into the two end brackets and decide on the best position of the riser rail in relation to the heater unit. (Refer to Section 2.6).

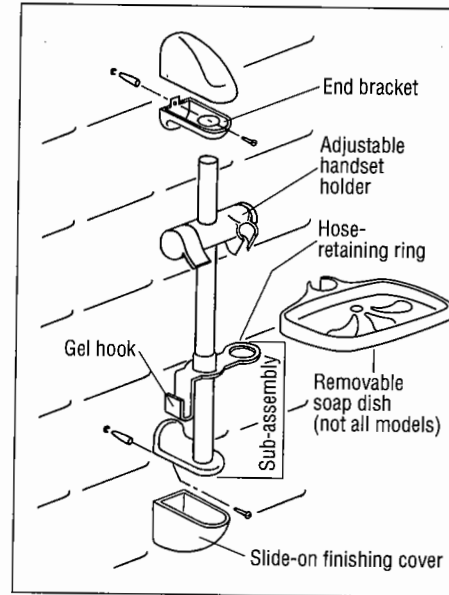

Figure 4.25

**4.26** Mark the position of the top screw hole and remove the riser rail from the wall. Drill and plug the screw hole.

The wallplugs provided are suitable for most brick walls (use a 7.0 dia. masonry drill), but if your wall is plasterboard or soft building block, you should use special wallplugs obtainable from most hardware suppliers.

**4.27** Secure the top end bracket using the screw provided.

**4.28** Assemble the handset holder and the soap dish holder (incorporating gel-hook and hose retainer) onto the riser rail and slot into bottom end bracket. See sub-assembly Fig. 4.25. NB Soap dish and gel hook are not supplied with all models.

**4.29** Slot riser rail into top end bracket and mark position of screw hole. Remove bottom end bracket and riser rail sub-assembly, drill and plug hole, then replace and screw to wall.

**4.30** Clip, or slide, the finishing covers onto the top and bottom end brackets, depending on the precise design.

**4.31** Secure one end of the hose to the handset, and screw the other end of the hose to the shower heater outlet. Ensure the black sealing washers are fitted.

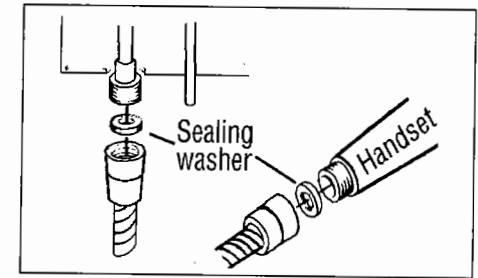

Figure 4.31

## Wiring:

**4.32** Design your system as outlined in Section Three. Lay the cable in your chosen route, ensuring that you have ample length.

**4.33** Leave the connection to the consumer unit or switch-fuse until last.

**4.34 Remember: when working on electrical components, ensure they are not live.** If in any doubt, switch off at your main switch at the fuseboard or consumer unit.

**4.35** If you find it necessary to increase access for fitting the cable, the shower can be unplumbed at its inlet pipe and temporarily removed from the wall.

**4.36** Feed the cable through the opening in the backplate below the terminal block.

**4.38** Ensure that all three screws hold the shower backplate to the wall firmly.

**4.41** Strip the outer insulation sheath back as required. Strip the insulation from the cores and make connections to the LIVE (L) (brown or red), NEUTRAL (N) (blue or black) and EARTH ( $\perp$ ) terminal block. The earth wire must be sleeved green/yellow. Make sure that the cores of the cable lie tidily and do not touch any metallic part of the shower. They must not be under strain. There is no cable clamp.

**4.42** Ensure that the cable does not foul the area above the bottom removable section, where the knob gear will fit when the front cover is fitted in place.

**4.43** Make sure that all the terminal block screws are tightened very firmly. Replace the bottom section of the backplate.

## Fitting the front cover:

**4.44** Turn the valve fully clockwise (open). Turn the water control knob in the cover anti-clockwise until it hits a stop. Its pointer should be at 1 o'clock.

**4.45** Carefully fit the cover to the backplate, ensuring that the lugs slide into their sockets. You may have to adjust the water control knob slightly to enable its gear to mesh with that on the control valve.

**4.46** The post on the underside of the front cover fits into the valve spindle socket. This should aid fitting of the cover.

**4.47** Fit the cover-fixing screws. The longer one is for the lower fixing point. You may have to push the front cover firmly against the backplate seal, to enable the screws to locate properly through the fixing lugs. Press the push-buttons in turn to check that their mechanism operates smoothly.

## Testing:

Once you have finished installing your shower, carry out the following tests to ensure that you have followed our installation instructions correctly and that your shower is functioning as it should.

**4.48** Secure the handset on the riser rail where it can spray safely. Press the 'low' button. Ensure the stop/start button is out. Turn the water control knob fully clockwise.

**4.49** Turn on the isolating valve (if applicable). Press the stop/start button. The 'Power on' light and the 'Low Flow/Reduce Temp' light should illuminate.

**4.50** Slowly turn the control knob anti-clockwise. There may be gurgling noises as water fills the heater can, then water will start to flow. Press the 'high' button.

**4.52** Turn the water control knob further anti-clockwise, until the 'Low Flow/Reduce Temp' light goes out. The elements are now heating.

**4.53** The temperature of the spray should now increase.

**4.54** Adjust the water control knob to give the desired temperature. Turn clockwise for warmer, anti-clockwise for cooler. Allow a few seconds after each adjustment for the temperature to stabilise. The high/low power selector push-buttons allow you to choose the power used by the heater.

The low setting, which uses less electricity, can be used in the summer to decrease the spray temperature, when the incoming water temperature is likely to be higher.

A cold shower cannot be obtained.

**4.55** Note the position that the knob is at. Turn it fully clockwise and note that the 'Low Flow/Reduce Temp' warning light goes on, indicating that the elements are no longer heating. Turn the water flow control knob anti-clockwise to the original position. The 'Low Flow/Reduce Temp' light should go out.

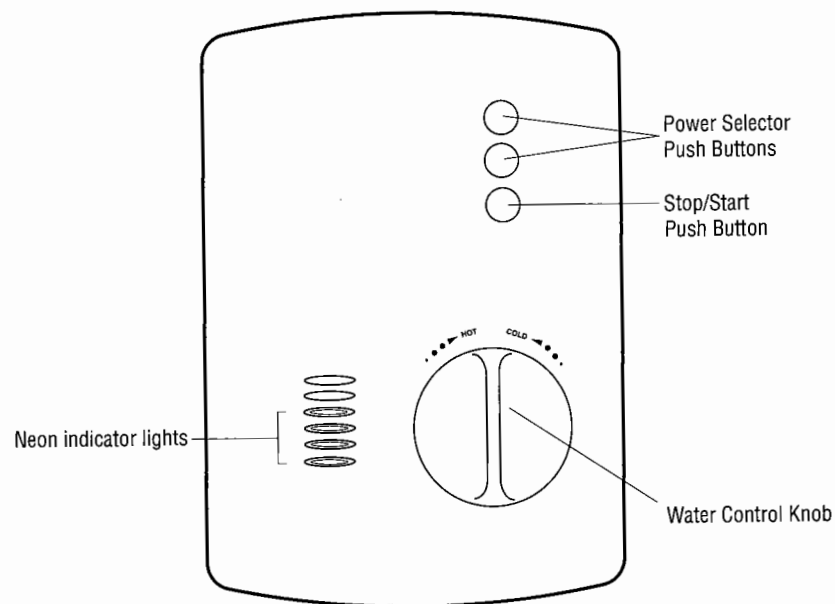

**Figure 4.54** External features of shower



# SECTION FIVE

## Fault-Finding

In the unlikely event of a problem, consult the trouble-shooting chart below.

For your particular symptom follow the suggested remedies in the order given. If you are unable to remedy the problem, **CONTACT YOUR INSTALLER IN THE FIRST INSTANCE.** Do not attempt any electrical or plumbing work unless you are competent to do so.

Symptom	Possible Cause	Remedy
1. No Flow or not enough Flow.	A. Electrical power to shower heater off.	A. Ensure that the electricity supply to the shower is switched on, and 'Power On' light is lit.
	B. Water control knob is turned fully clockwise.	B. Turn water control knob anti-clockwise.
	C. Water turned off at mains or servicing valve.	C. Ensure water is fully turned on at the mains and at servicing valve in circuit.
	D. SHOWER HEATER SUSPECTED OF BEING FROZEN.	D. If so, DO NOT USE. (i) Switch off immediately at isolating switch. (ii) Turn water off at servicing valve (if fitted) or at stop cock. (iii) Contact our Service Department.
	E. There may be an outlet blockage.	E. Disconnect handset from hose and run the shower. (i) If water flows, then the handset is blocked with scale or debris. Remember that disturbances to plumbing elsewhere in your house, or in the street, can dislodge debris which can find its way to the shower. Clean the handset and spray rings/plate thoroughly. (ii) If water does not flow, remove the hose from the shower outlet. (a) If water then flows, the hose is blocked. This could be due to damage, severe kinking or even an obstruction. Replace with a new hose. (b) If the water does not flow, there is a blockage in the plumbing to the shower, or the shower itself. Contact our Service Department if the shower is considered to be the problem.

Symptom	Possible Cause	Remedy
2. Flow adequate but water too cold.	F. Cover/knob fitted incorrectly, limiting knob movement.	F. Switch off at isolating switch. Remove front cover and refit as in para 4.44, taking care to position knob correctly.
	A. Shower heater is on the "Low" power setting.	A. Ensure that shower is on "High" setting where applicable.
	B. Water flow too high.	B. Reduce the flow by turning the water control knob clockwise slowly. <b>NOTE:</b> If the knob is turned too far clockwise, the safety pressure switch inside the shower will turn off the heating elements. This is apparent when the indicator light on the shower goes out and/or the 'low flow'/'reduce temp' light (where applicable) comes on. If this happens, turn the knob anti-clockwise until the light(s) revert to their original state.
3. Water too hot.	C. Cover/knob fitted incorrectly, limiting knob movement.	C. Switch off at isolating switch. Remove front cover and refit as in para 4.44, taking care to position knob correctly.
	A. Water flow too low.	A. Increase the flow by turning the water control knob anti-clockwise slowly.
	B. Spray plate blocked with scale and debris.	B. Clean the handset spray plate.
	C. Water pressure too low.	C. Switch to "low setting", if applicable.
4. Water runs from around hose. Pressure relief device (PRD) has operated due to excess pressure build-up.	D. Cover/knob fitted incorrectly, limiting knob movement.	D. Switch off at isolating switch. Remove front cover and refit as in para 4.44, taking care to position knob correctly.
		Turn off isolating switch and servicing valve.
	A. Handset blocked.	A. Clean out the spray plate as in "Maintenance", Section 6. Call a service engineer to remove the front cover and reset the PRD by removing the bent bracket, pushing the black outlet boss back into the heat exchanger and refitting a new bracket.

*continued over*

Symptom	Possible Cause	Remedy
4. <i>continued.</i>		If the fault occurs again without the hose being damaged or the handset blocked, contact our Service Department.
	B. Hose damaged or kinked.	B. Replace kinked or damaged hose and be careful not to turn water control knob too far anti-clockwise. Reset as in "A".
5. Temperature varies whilst showering, cycling hot/cold.	A. Thermal cut-out is operating, normally making a "click" as it does so.	A. Increase the flow by turning the water control knob anti-clockwise. Clean the handset and spray plate.
	B. Input pressure is below the minimum required (see section 2.1). Flow is unstable.	B. Ensure that your stop cock and servicing valve are fully open. If they are, ask your installer or the local water company to check that the running pressure is above the minimum required (See para. 2.1).
6. No flow "Power On" indicator not lit. Isolating switch "On" but its neon not lit.	A. Cartridge fuse or miniature circuit breaker (mcb) has operated in your fusebox (or consumer unit) or switch fuse.	A. Switch off shower and isolating switch. Renew fuse or reset mcb. If they operate a second time, contact a qualified electrician.
	B. Residual current device (rcd) (earth leakage circuit breaker) has operated.	B. Follow the same procedure as above. If this has happened with a "split load" consumer unit on initial installation, check that the neutral core of the shower feed cable is connected to the "protected" neutral bar of the unit.

Where the fault cannot be corrected by either yourself or your installer, contact our service department (address and phone number on front cover), who will try to help over the phone. If necessary, they can arrange a visit by one of our service engineers. We find that the vast majority of

problems can be solved by reference to these fitting instructions or by discussion over the phone. In the event that our engineer is called and finds that the fault is caused by faulty installation or usage, or lack of reasonable maintenance, a call-out charge will be made.

## SECTION SIX

### User Instructions

#### 6.1 To turn on and set temperature:

- Turn on your isolating switch.
- Ensure power-setting button or knob is set to 'high'. Press the stop/start button.
- Turn water control knob anti-clockwise to allow water to flow until 'low flow'/'reduce temp' light goes out, or 'power on' light goes on; then the shower is heating.

**WARMER** – DECREASE FLOW – TURN KNOB CLOCKWISE

**COOLER** – INCREASE FLOW – TURN KNOB ANTI-CLOCKWISE

Make adjustments carefully. Give the shower a few seconds after each adjustment to stabilise, then check the temperature by hand before stepping into the shower. The 'low' setting cuts out one heating element and so can be used to save energy in the summer months when incoming water temperatures are higher, or simply to reduce the spray temperature.

#### 6.2 To turn off:

- Press the stop/start button.
- Turn off your isolating switch.

### Handset Styles

Handset 1

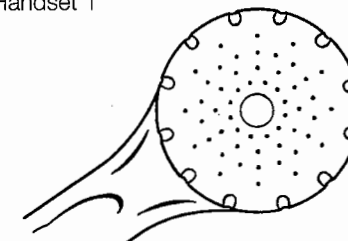

Handset 2

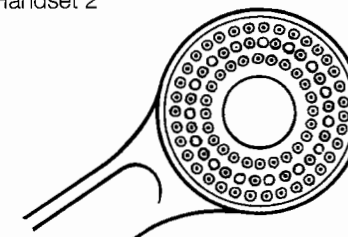

Handset 3  
Multi-mode

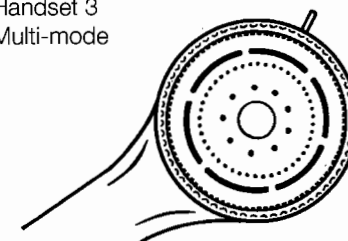

Handset 4  
Multi-mode

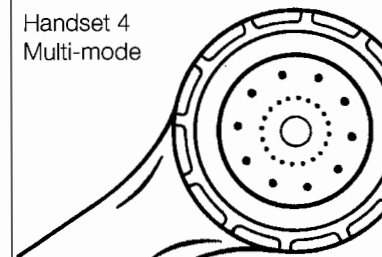

Handset 5

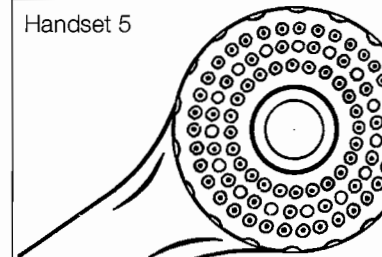

### Handsets

**It is recommended that periodically the handset is immersed and soaked in a proprietary descalant overnight.**