

DT20 PROGRAMMER

DIGITAL TWIN CHANNEL PROGRAMMER
FOR GREENSTAR_i and GREENSTAR Si MODELS

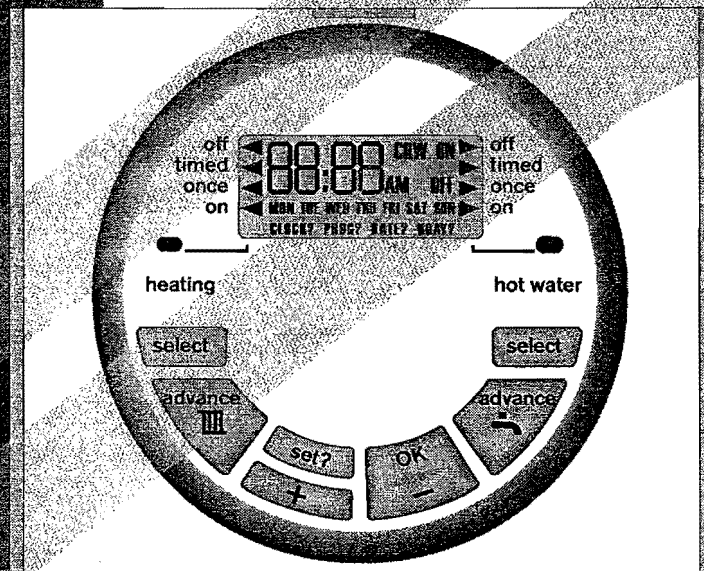

 **WORCESTER**
Bosch Group

INSTRUCTION MANUAL
FITTING & OPERATING INSTRUCTIONS

CONTACT INFORMATION

WORCESTER BOSCH:

TECHNICAL: 08705 266241
SERVICE: 08547 256206
SPARES: 01905 752571
LITERATURE: 01905 752556
TRAINING: 01905 752526
SALES: 01905 752640
WEBSITE: www.worcester-bosch.co.uk

MANUAL INFORMATION

PLEASE READ THESE INSTRUCTIONS CAREFULLY BEFORE STARTING

THESE INSTRUCTIONS ARE APPLICABLE TO THE WORCESTER BOSCH MODEL(S) STATED ON THE FRONT COVER OF THIS MANUAL ONLY AND MUST NOT BE USED WITH ANY OTHER MAKE OR MODEL

THE INSTRUCTIONS APPLY IN THE UK ONLY AND SHOULD BE FOLLOWED EXCEPT FOR ANY STATUTORY OBLIGATION

IF YOU ARE IN ANY DOUBT CONTACT WORCESTER BOSCH TECHNICAL HELPLINE

THIS ACCESSORY MUST BE FITTED BY A COMPETENT PERSON. FAILURE TO COMPLY COULD LEAD TO PROSECUTION.

LEAVE THESE INSTRUCTIONS WITH THE USER OR AT THE APPLIANCE.

ABBREVIATIONS:



CH	Central Heating	GMT	Greenwich Mean Time
HW	Domestic Hot Water	C	Celcius
RF	Radio Frequency	m	Metre
DLS	Day Light Saving	IP	Ingress Protection
BST	British Summer Time	V	Volts
		mA	MilliAmps

DEFINITIONS (DLS/BST):

Summer period begin: Last Sunday in March at 1:00 AM GMT (Clock put forward by 60 minutes)

Summer period end: Last Sunday in October at 2:00 AM GMT (Clock put back by 60 minutes)

SYMBOLS:

	Central Heating
	Domestic Hot Water

CONTACT & MANUAL
INFORMATION

FITTING & OPERATING INSTRUCTIONS FOR WORCESTER BOSCH
TWIN CHANNEL DT20 PROGRAMMER
8-716-106-647 issue b (11.04) UK

 **WORCESTER**
Bosch Group

CONTENTS

ACCESSORY INFORMATION

GENERAL INFORMATION	2
TECHNICAL DATA	3

INSTALLATION & COMMISSIONING

FITTING THE DT20	4
------------------	---

USER INSTRUCTIONS

OPERATING CONTROLS	5
PRESET PROGRAMS	6
SETTING PROGRAMS	
Setting CH Mon-Fri • Setting HW Mon-Fri	7
Setting individual weekdays	8
Setting CH Sat-Sun • Setting HW Sat-Sun	9
Setting individual weekend days	10
SETTING HOLIDAYS	11
SETTING THE CLOCK	12
SETTING THE DATE	13

SERVICING & SPARES

MAINTENANCE & SPARES	14
----------------------	----

CONTENTS

ACCESSORY
INFORMATION

INSTALLATION &
COMMISSIONING

USER
INSTRUCTIONS

SERVICING
& SPARES

GENERAL INFORMATION

STANDARD PACKAGE:

- A - Programmer
- B - Instructions

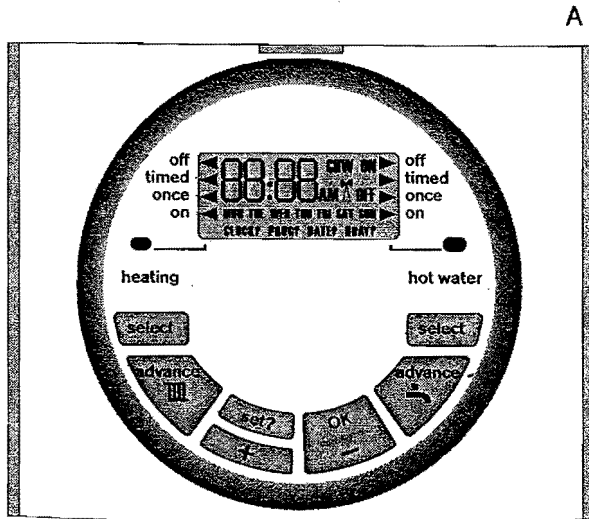

SPECIFICATIONS:

- Twin channel programmer for CH & DHW mounted into the boiler fascia
- 7 day programmer
- 3 on/off periods per day
- Automatic BST settings
- Pre-programmed on/off periods
- Dedicated advance buttons
- 12 or 24 hour back-lit digital display
- Holiday function
- Pre-wired with PCB connector

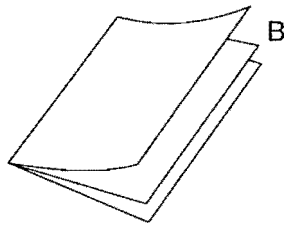

TECHNICAL DATA

DESCRIPTION	UNITS	DT20
Dimensions	mm	-
Electrical supply	-	24v DC <65mA
Ambient operating temperature	°C	0 to +50
Humidity operating range	% non-condensing up to 45°	30 - 95
Class of protection	-	II
Degree of protection	IP	20
Accuracy @ 25°C	sec/day	<±1
Battery life	years	10
Battery backup time & date	years min.	10
Shortest switching period	minutes	1
DHW & CH On/Off periods	number	3
DHW & CH Programs	days	7

ACCESSORY INFORMATION

Related Standards:

BS EN60730-1:2001

BS EN60730-2-7:1992

Electro Magnetic Compatibility and Radio Spectrum Matters (ERM); Short Range Devices (SRD) ETSI EN 300 220-1

EC Directives:

European Union Law Directive 2000/84/EC

Low Voltage Directive (73/23/EEC)

Electro Magnetic Compatibility Directive (89/336/EEC)

CE Marking Directive (93/68/EEC)

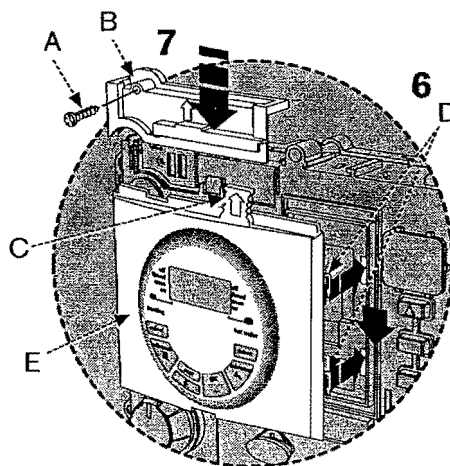
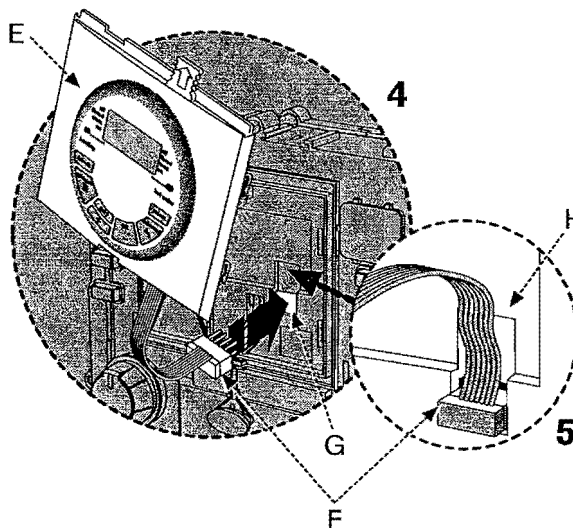
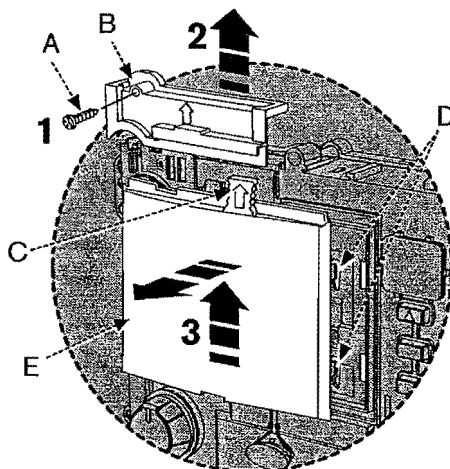

FITTING THE DT20



DANGER - 24V & 230V: DO NOT TOUCH THE ELECTRICAL COMPONENTS OR CIRCUITS.

CAUTION: ISOLATE THE MAINS ELECTRICITY SUPPLY BEFORE STARTING ANY WORK AND OBSERVE ALL RELEVANT SAFETY PRECAUTIONS.

OBSERVE ELECTRONIC STATIC DISCHARGE PRECAUTIONS. DO NOT TOUCH THE PCB CIRCUITS

- ▶ **Important: Switch off boiler**
- ▶ Remove boiler outer casing and control panel fascia to gain access to the heatronic control panel
- 1 Release securing screw (A)
- 2 Pull cover panel (B) upwards to remove
- 3 Grip tab (C), pull upwards to disengage clips (D) and pull forwards to remove blanking plate (E) or existing programmer
- 4 Align connector pins (F) into receptors (G) in the pcb and push fully home
- 5 Feed the ribbon cable (G) into recess (H)
- 6 Align programmer (E) and locate clips (D), push into slots then downwards to secure using grip tab (C)
- 7 Locate cover panel (B) and secure with screw (A)
- ▶ Replace fascia cover and outer casing before switching on the electricity supply and boiler
- ▶ Switch boiler on when completed.
- ▶ Refer to 'USERS INSTRUCTIONS' section for details of pre-set and setting programs.

OPERATING CONTROLS

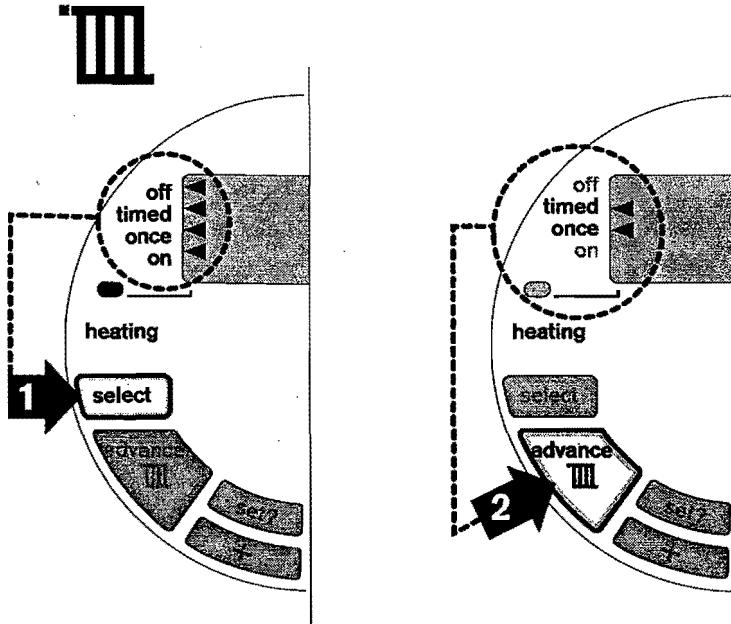

Central heating:

1 Press 'select' button to choose:

off ◀ = constantly OFF

timed ◀ = up to 3 ON and 3 OFF time periods as program

once ◀ = ON from 1st ON until 3rd OFF time period as program

on ◀ = constantly ON

2 Press 'advance' button:

ON = heating light on (heating stays on until the next OFF time period)

OFF = heating light off (heating stays off until the next ON time period)

Note: 'advance' will not function with constant on or off selected.

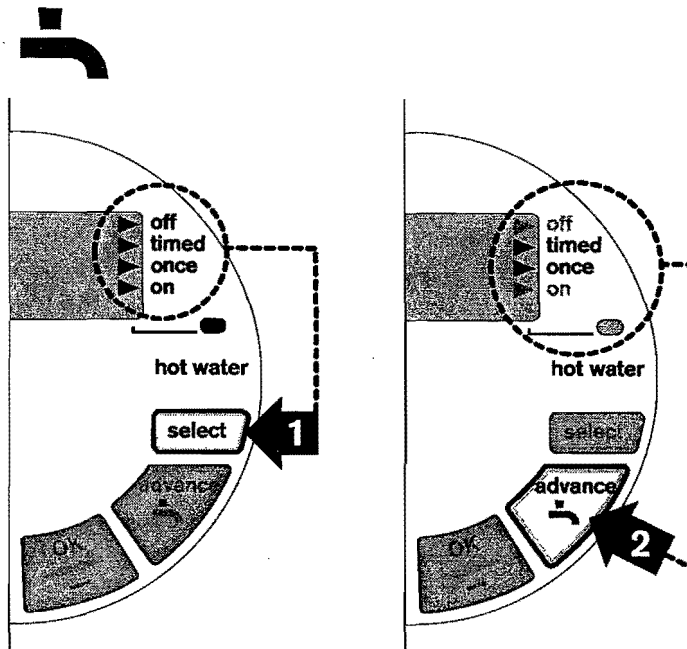

Hot Water:

1 Press 'select' button to choose:

▶ **off** = constantly OFF

▶ **timed** = up to 3 ON and 3 OFF time periods as program

▶ **once** = ON from 1st ON until 3rd OFF time period as program

▶ **on** = constantly ON

2 Press 'advance' button:

ON = hot water light on (hot water stays on until the next OFF time period)

OFF = hot water light off (hot water stays off until the next ON time period)

Note: 'advance' will not function with constant on or off selected.

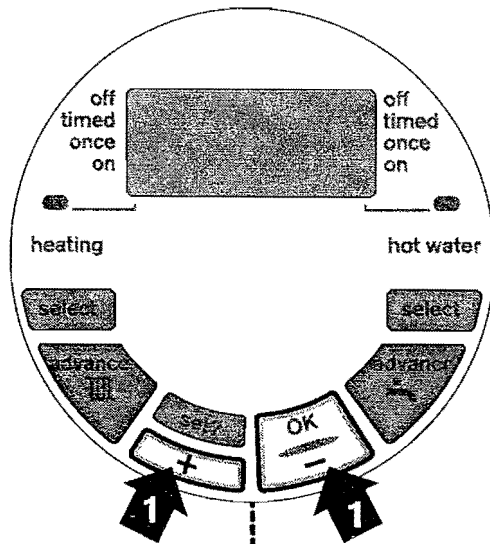

PRE-SET PROGRAMS

If you need to restore the factory pre-set program times then:

- 1 Press the '-' and '+' buttons together to restore the default program times to those shown in the table opposite.

The default ON/OFF periods pre-programmed for CH and DHW are shown in the table opposite.

Note: two ON/OFF periods can be used instead of 3 by setting the 2nd ON & OFF periods to 12.00 as shown in the default program table.

One ON/OFF period can be achieved by setting the 2nd and 3rd ON & OFF periods to the same time.

Note: The clock time is pre-programmed and should not require adjustment.

See 'SETTING PROGRAMS' in the USER INSTRUCTIONS section if changes are required to the clock time or pre-programmed settings.

	1st ON	1st OFF	2nd ON	2nd OFF	3rd ON	3rd OFF
Central Heating:						
<i>MON to FRI</i>						
Time	6:30	8:30	12:00	12:00	16:30	22:30
<i>SAT & SUN</i>						
Time	7:00	9:00	12:00	12:00	16:00	23:00
Hot Water:						
<i>MON to FRI</i>						
Time	6:30	8:30	12:00	12:00	16:30	22:30
<i>SAT & SUN</i>						
Time	7:00	9:00	12:00	12:00	16:00	23:00

SETTING PROGRAMS

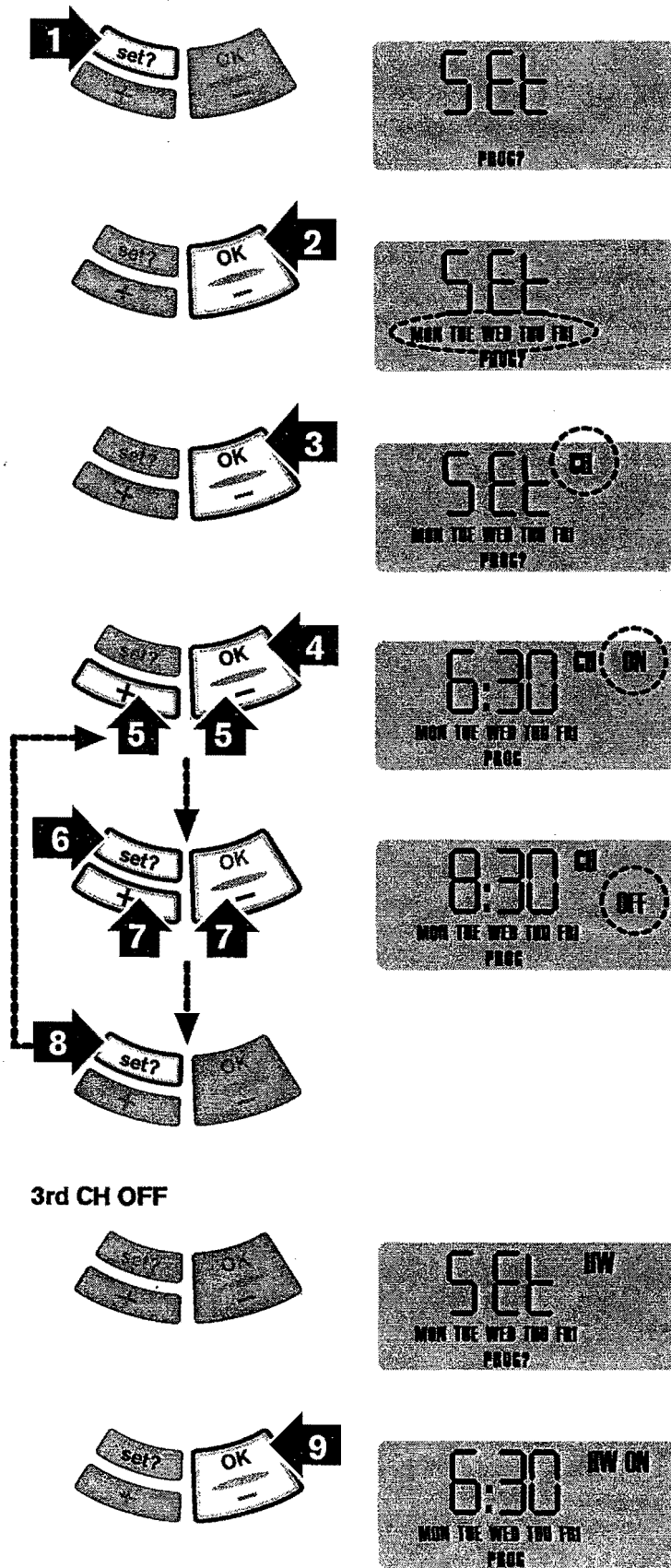

3rd CH OFF

Note: if you require different ON/OFF times during the week, see 'Setting individual days'

Setting CH MON - FRI:

1 Press 'set?' until 'SET' & 'PROG?' are shown in the display

2 Press 'OK' to enter program

3 Press 'OK' to select MON-FRI

4 Press 'OK' to select CH

Note: speed up the display by holding down the '+' or '-' buttons.

5 Press '+' or '-' to change the ON time

6 Press 'set?' to set the ON time and select the OFF time

7 Press '+' or '-' to change the OFF time

8 Press 'set?' to set the OFF time and select the next ON time

Repeat operations 5 to 8 to set the 2nd and 3rd CH ON/OFF times.

Note: after pressing 'set?' for the 3rd CH OFF time the display shows 'SET' HW MON-FRI

Setting HW MON - FRI

9 Press 'OK' to select the first ON time

Repeat operations 5 to 8 to set the 1st, 2nd and 3rd HW ON/OFF times.

Note: after pressing 'set?' for the 3rd HW OFF time the display shows 'SET' MON... see next page

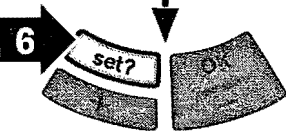
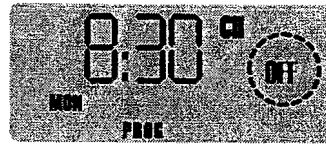
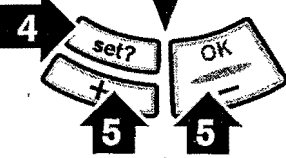
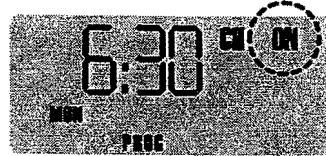
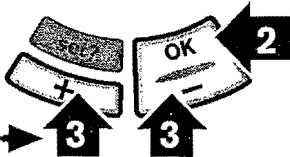
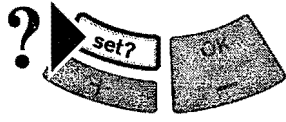

3rd CH OFF

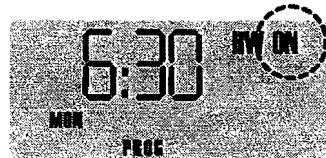

SETTING PROGRAMS

Setting individual weekdays:

Note: if you do not require individual weekday times, then press 'set?' until 'SET' SAT-SUN are displayed and continue on the next page.

- ▶ If you do not wish to change the settings for the day displayed, then press 'set?' until the first day you want to change is displayed

Setting CH individual weekdays:

- 1 Press 'OK' to select weekday
- 2 Press 'OK' to select CH

Note: speed up the display by holding down the '+' or '-' buttons.

- 3 Press '+' or '-' to change the ON time
- 4 Press 'set?' to set the ON time and select the OFF time
- 5 Press '+' or '-' to change the OFF time
- 6 Press 'set?' to set the OFF time and select the next ON time

Repeat operations 3 to 6 to set the 2nd and 3rd CH ON/OFF times.

Note: after pressing 'set?' for the 3rd CH OFF time the display shows 'SET' HW for that weekday

Setting HW individual weekdays:

- 7 Press 'OK' to select the first ON time

Repeat operations 3 to 6 to set the 1st, 2nd and 3rd HW ON/OFF times.

Note: after pressing 'set?' for the 3rd HW OFF time 'SET' and the next weekday are displayed shown . . . after completing the steps above for FRI the display shows 'SET' SAT SUN (see next page)

SETTING PROGRAMS

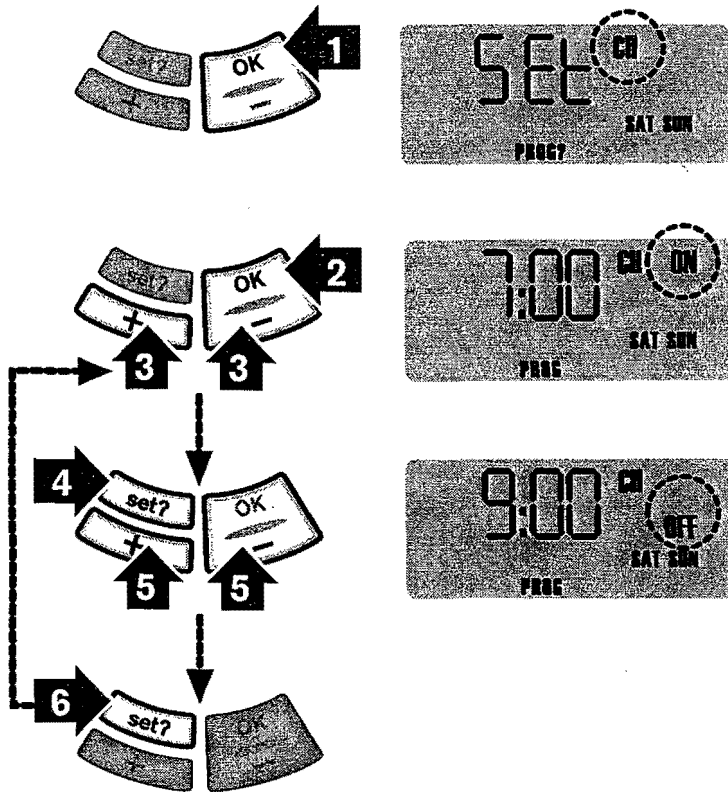

Setting CH SAT - SUN:

- 1 Press 'OK' to select weekend
- 2 Press 'OK' to select CH

Note: speed up the display by holding down the '+' or '-' buttons.

- 3 Press '+' or '-' to change the ON time
- 4 Press 'set?' to set the ON time and select the OFF time
- 5 Press '+' or '-' to change the OFF time
- 6 Press 'set?' to set the OFF time and select the next ON time

Repeat operations 3 to 6 to set the 2nd and 3rd CH ON/OFF times.

Note: after pressing 'set?' for the 3rd CH OFF time the display shows 'SET' HW for that weekday

3rd CH OFF

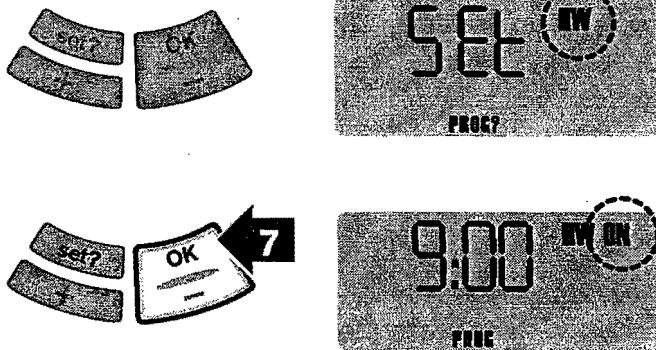

Setting HW SAT - SUN:

- 7 Press 'OK' to select the first ON time
- Repeat operations 3 to 6 to set the 1st, 2nd and 3rd HW ON/OFF times.

Note: after pressing 'set?' for the 3rd HW OFF time the display shows 'SET' SAT, see next page.

If you do not require individual weekend times, then press 'SET?' until the normal display is resumed.

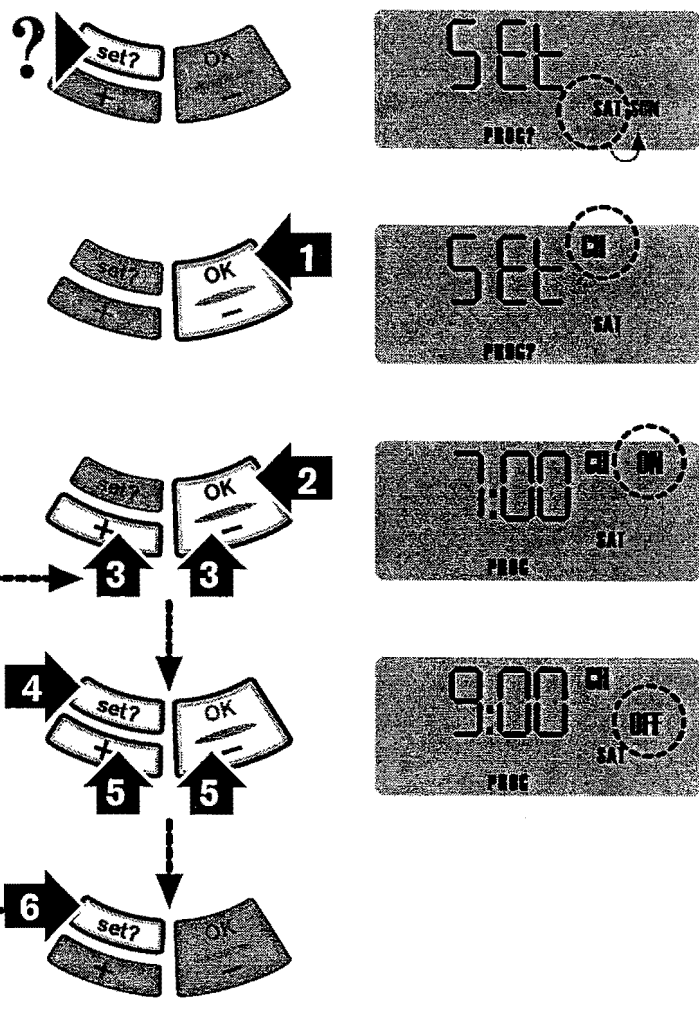

3rd CH OFF

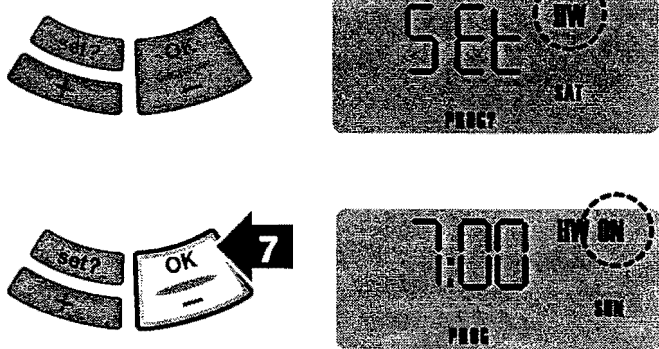

SETTING PROGRAMS

Setting individual weekend days:

Note: if you do not require individual weekend times, then press 'set?' until normal display is shown.

- ▶ If you do not wish to change the settings for 'SAT', then press 'set?' to move to 'SUN'

Setting CH individual weekend days:

- 1 Press 'OK' to select day displayed
- 2 Press 'OK' to select CH

Note: speed up the display by holding down the '+' or '-' buttons.

- 3 Press '+' or '-' to change the ON time
- 4 Press 'set?' to set the ON time and select the OFF time
- 5 Press '+' or '-' to change the OFF time
- 6 Press 'set?' to set the OFF time and select the next ON time

Repeat operations 3 to 6 to set the 2nd and 3rd CH ON/OFF times.

Note: after pressing 'set?' for the 3rd CH OFF time the display shows 'SET' HW for that day

Setting HW individual weekend days:

- 7 Press 'OK' to select the first ON time
- Repeat operations 3 to 6 to set the 1st, 2nd and 3rd HW ON/OFF times.

- ▶ Press 'set?' until the display returns to normal mode.

SETTING HOLIDAYS

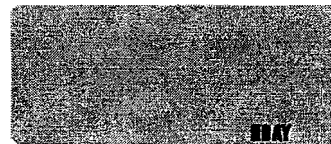
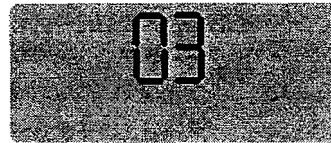
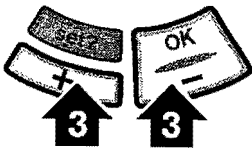
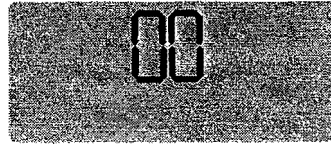
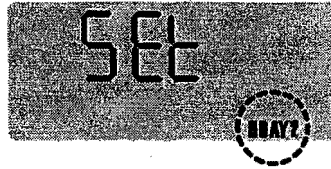
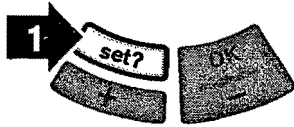

- 1 Press the 'set?' button until 'SET' & 'HDAY?' is displayed
- 2 Press 'OK' the display shows 00
- 3 Press '+' & '-' to set the number of days you require the system to be off
- 4 Press 'set?' then 'HDAY' is shown in the display and no demand for heating will be made from the programmer.

The program will return to normal after the set number of days.

- ▶ To cancel the holiday setting and return to normal operation, press any button.

Note: the programmer counts each pass through midnight as a day.

For example, if you don't want the heating on from Saturday morning until Tuesday morning, set for 3 days.

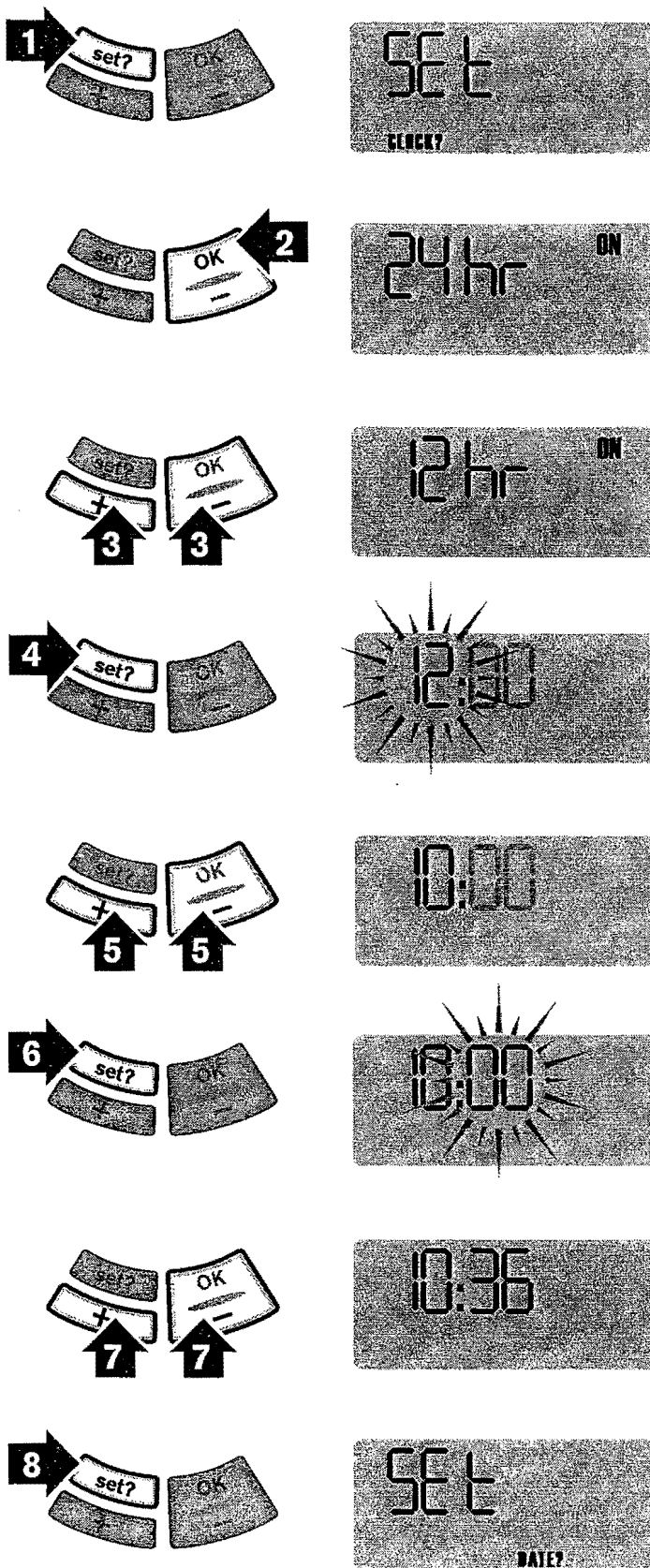

SETTING THE CLOCK

- 1 Press the 'set?' button until 'SET' & 'CLOCK?' are shown in the display
- 2 Press 'OK' displays '24hr' & 'ON'
- 3 Press '+' to toggle between 24hr and 12hr display
- 4 Press 'set?' to set the clock and the hours flash on the display
- 5 Press '+' or '-' to correct hour
- 6 Press the 'set?' button to set the correct hour
- 7 Press '+' or '-' to correct minutes
- 8 Press the 'set?' button to set the correct minutes. 'SET' & 'DATE?' appears in the display.

Note: speed up the display by holding down the '+' or '-' buttons.

Note: if the day displayed is incorrect the date needs resetting. To change the date see 'SETTING THE DATE'. If you do not wish to change the date, press 'set?' to return to normal display.

SETTING THE DATE

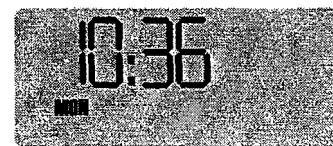
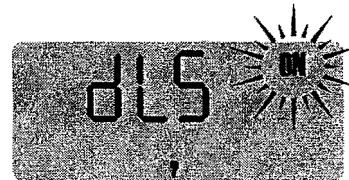
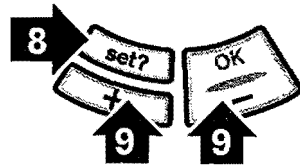
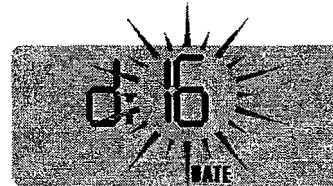
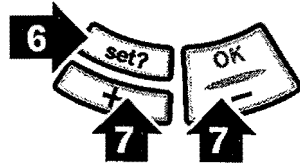
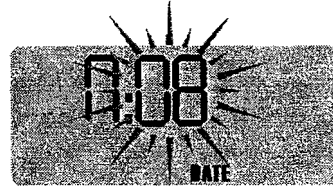
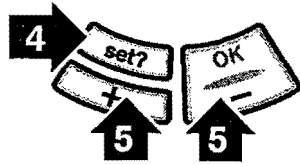
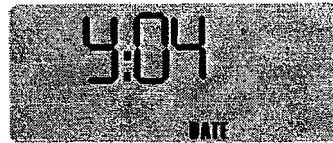
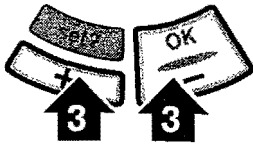
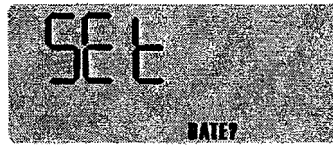

Note: if the day displayed is incorrect the date needs resetting as follows:

- 1 Press the 'set?' button until 'SET' & 'DATE?' are shown in the display
- 2 Press the 'OK' button once, the year flashes on the display
- 3 Press '+' or '-' to correct year
- 4 Press the 'set?' button and the month flashes on the display
- 5 Press '+' or '-' to correct month
- 6 Press the 'set?' button and the day flashes on the display
- 7 Press '+' or '-' to correct day
- 8 Press the 'set?' button to set the DLS and 'ON' flashes
- 9 Press '+' or '-' for 'ON' or 'OFF'
- 10 Press 'set?' to return to normal display.

MAINTENANCE & SPARES

Maintenance:

- ▶ The programmer requires no maintenance
- ▶ The outer casing can be wiped clean using a dry cloth, do not use polish or detergents

Servicing:

- ▶ This unit cannot be serviced.
- ▶ Should the existing unit fail to function correctly, check that the times and program settings are correct.

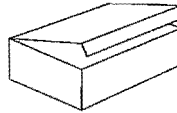

Replacement Parts:

- ▶ DT20 programmer replacement part number: 8-716-106-665-0