

MS001 / MS002 Single Oven
Manual for Installation, Use and Maintenance



Important

This appliance must only be used for the purpose for which it is intended, i.e. domestic cooking. Any other use could be dangerous and may lead to premature failure of the appliance.

The CDA Group Ltd cannot be held responsible for injuries or losses caused by incorrect use or installation of this product. Please note that CDA reserve the right to invalidate the guarantee supplied with this product following incorrect installation or misuse of the appliance.

Under no circumstances should any external covers be removed for servicing or maintenance except by suitably qualified personnel.

User information:

- Ovens become hot during and immediately after use.
- The oven door can become very hot during operation.
- After use, please ensure that the oven switches are in the 'Off' position.
- Keep children away from the appliance when in use, and immediately after use.
- Keep the oven door closed whilst grilling.

Appliance information:

Please enter the details on the appliance rating plate below for reference, to assist CDA Customer Care in the event of a fault with your appliance and to register your appliance for guarantee purposes.

Appliance Model	
-----------------	--

Serial Number	
---------------	--

CE Declarations of Conformity:

This oven has been designed, constructed and marketed in compliance with safety requirements of EEC Directive 2006/95/EEC (Low voltage) and requirements of EMC Directive 2004/108/EEC.

This appliance has been manufactured to the strictest standards and complies with all applicable legislation, including Electrical safety (LVD) and Electromagnetic interference compatibility (EMC). Parts intended to come into contact with food conform to EEC/89/109.4

IMPORTANT INFORMATION FOR CORRECT DISPOSAL OF THE PRODUCT IN ACCORDANCE WITH EC DIRECTIVE 2002/96/EC.

At the end of its working life, the product must not be disposed of as urban waste. It must be taken to a special local authority differentiated waste collection centre or to a dealer providing this service.

Disposing of a household appliance separately avoids possible negative consequences for the environment and health deriving from inappropriate disposal and enables the constituent materials to be recovered to obtain significant savings in energy and resources. As a reminder of the need to dispose of household appliances separately, the product is marked with a crossed-out wheeled dustbin. 

Important

- Read the user instructions carefully before using the oven for the first time.
- Follow the instructions for first use of the oven.
- Clean the oven regularly.
- Remove spills as soon as they occur.
- Always use oven gloves when removing shelves and trays from the ovens.
- Do not allow children near the oven when in use.
- Do not allow fat or oils to build up on the oven shelves, grill pan or oven base.
- Do not place any cooking utensils or plates directly on the oven base.
- Always grill with the oven door closed.
- Do not grill food containing fat without using the grill pan grid.
- Do not cover the grill pan grid or the oven walls with aluminium foil.
- Do not use the oven tray for roasting.
- Do not perform maintenance or cleaning of the oven without first switching off the electricity supply. If the oven has recently been used, allow to cool.
- Do not place hot enamel parts in water. Leave them to cool first.
- Do not allow vinegar, coffee, milk, saltwater, lemon or tomato juice to remain in contact with enamel parts.
- Do not use abrasive cleaners or powders that will scratch the surface of the enamel.
- Do not attempt to repair the internal workings of your oven.

First use of the oven

First use

- Before using the oven for the first time we recommend that you clean the oven with soapy water, rinse carefully and then heat on each of the below programmes at maximum temperature for the specified time. A slightly unpleasant smell may be produced, caused by grease remaining on the oven elements from the production process.

 15 minutes grill.

 60 minutes fan oven.

Please note:

- This oven has been fitted with a cooling fan to achieve maximum efficiency and to maintain low surface temperatures. The cooling fan will switch on automatically when the oven switches on. It is normal for the cooling fan to run for an hour or more after use, depending on the duration, temperature and type of cooking programme used.
- The oven light remains on for every cooking function.
- Do not switch off the oven if you have set a programme for semi-automatic or automatic cooking as this will cancel the programme (MS002 only).

Oven controls and use

Cooking function knob

To set the function, turn the cooking function knob to the required function.

Each of the oven functions uses different elements within the oven to offer you the best choice of cooking every time. These are explained below:



Defrost

Using the fan only this oven function circulates the air around the oven cavity, speeding up the natural defrost process (1kg takes approximately one hour, depending on the type of food).



Fan Oven

Using the circular element and the fan with a temperature between 50°C and 250°C, this cooking function blows the air into and around the oven cavity. Temperatures are achieved quicker, reducing or even removing the need for preheating. Both cooking temperatures and cooking times can be reduced for a more energy efficient cooking programme.



Full Grill

This function radiates the heat from the grill element and the top element.

This fully temperature variable grill is ideal for grilling a full family meal. It can be set between 50°C and 250°C maximum.



Half Grill

This function radiates the heat from the grill element.

This fully temperature variable grill can be set between 50°C and 250°C maximum.

For each grill function please note:

- Always grill with the oven door closed.
- Put the grill pan as close to the grill as possible.
- Do not grill for more than 30 minutes at a time.
- Preheat the grill for up to five minutes with the oven door closed.

Temperature knob

- To set the temperature, turn the temperature knob clockwise to the required temperature.
- Once the oven has reached the required temperature, the temperature indicator lamp on the control panel will switch off.
- The temperature indicator lamp will light up when the oven elements are in operation.

Programming the oven (MS002 only)

IMPORTANT: THE CLOCK MUST BE SET TO ENABLE THE OVEN TO WORK.

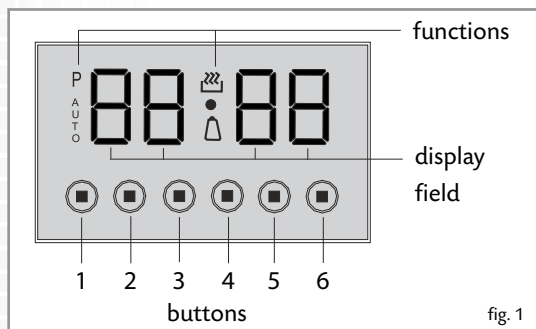

To confirm a selection when programming the clock/timer, once the display shows the preferred selection simply do not touch any further keys for approximately five seconds. The oven will automatically confirm the selection.

The alert beep will cut off after seven minutes if it is not switched off manually.

Setting the clock

The clock is preset to 00:00, and will revert to this after a power failure.

- With the oven switched off, press buttons 2 and 3 at the same time.
- Select the correct time by pressing the increase and decrease buttons.
When the correct time is shown on the display, the clock will set after approximately five seconds' delay.

Setting the volume of the beep

- When the current time is shown on the clock display, press and hold button 5. The beep will sound three times.
- Continue to press button 5 until the volume is at the correct level. Each press of the button will cycle through the options.

The minute minder

The minute minder can be used when the oven is switched on or off. It can be set for up to 23 hours and 59 minutes.

To set the minute minder:

- Press button 1.
- Then press buttons 5 and 6 to select the required duration for the minute minder. When the correct duration shows on the display, the minute minder will set after approximately five seconds delay.
- A bell symbol will show in the clock display to indicate the minute minder is on.
- When the countdown is complete, there will be a beep which will continue for seven minutes. To switch off the beep, press any button.
- To cancel the timer, press button 1 and then buttons 5 and 6 simultaneously.

Please note :

At the end of the countdown, the minute minder will not switch off the oven. Remember to turn off the oven manually.

Programming the oven (MS002 only)

The oven can be set for semi-automatic cooking, where the oven is programmed to switch off at a specific time, and for automatic cooking, where the oven is set to switch on and off at specific times.

To use the oven, first press button 4

To set a semi-automatic programme

1. Select the required function and temperature (the oven will switch on).
2. Press button 2 and then press button 5 or 6 to select the required duration of cooking (maximum of 10 hours). The auto symbol will show on the clock display to indicate a programme has been set.

To set a fully automatic cooking programme, follow step 1 and 2 above, and then:

3. Press button 3. The clock will show the predicted end time (i.e. the programmed cooking time added on to the current time).
4. Press button 5 or 6 to select the required end time for cooking. The programme symbol will no longer show on the clock display, but auto will still show. When the cooking programme begins, the programme symbol will show in the clock display.

To check on the time remaining on the programme, press button 2.

To check on the specified end time, press button 3.

When the cooking time is completed, the programme symbol will no longer be shown, auto will flash and the timer will beep. To switch off the beep, press any button. Then switch off the oven by turning the control knobs to the off position and pressing button 4 to set the programmer to manual.

To cancel a programme

Press buttons 2 and 3 simultaneously, or button 4.

Please note :

At the end of a programme, the timer will not switch off the oven.

Remember to turn off the oven manually.

Care and Maintenance

IMPORTANT

Before any maintenance is started involving electrical parts, the appliance must be disconnected from the power supply.

If the oven has been in use, let the oven cavity and the heating elements cool down before attempting any maintenance.

The oven exterior

As the oven has a stainless steel or enamel surface, you should use a nonabrasive cleaner. Any abrasive cleaner (including Cif) will scratch the surface and could erase the control panel markings. Stainless steel can be effectively cleaned by simply using a dilute solution of water and mild detergent and drying to a shine with a clean cloth.

Proprietary stainless steel cleaners are available. We recommend the CDA E-Cloth available from the CDA Sales Team for cleaning stainless steel surfaces as this has been designed to prolong the finish of your appliance.

Inside of Oven

The oven should always be cleaned after use when it has cooled down.

The cavity should be cleaned using a mild detergent solution and warm water.

Suitable proprietary chemical cleaners may be used after first consulting with the manufacturers recommendations and testing a sample on a small area of the oven cavity. Abrasive cleaning agents or scouring pads/cloths should not be used on the cavity surface.

IMPORTANT:

- **Steam cleaners must not be used when cleaning this appliance.**
- **Once care and maintenance is complete, ensure that all parts are correctly replaced before using the oven.**

Changing the Oven Lamp

Before any maintenance is started involving electrical parts, the appliance must be disconnected from the power supply.

If the oven has been in use, let the oven cavity and the heating elements cool down before attempting any maintenance.

Changing the bulb (fig. 2)

- Unscrew the protective cover.
- Unscrew and replace the bulb with the new one suitable for high temperatures (300°C) having the following specifications: 230-240V, 50Hz, 25W E14 (SES).
- Refit the protective cover.

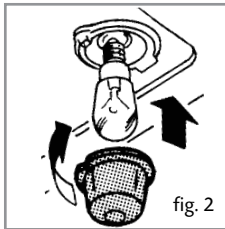

IMPORTANT: Never use screwdrivers or other utensils to remove the light cover. This could damage the enamel of the oven or the lamp holder. Remove only by hand.

Please note:

The bulb replacement is not covered by your guarantee.

Installation

Important

If the oven is being installed into a built under oven housing unit ensure that the front rail at the top of the unit is not installed as it could restrict ventilation.

Ensure that air can flow freely around the housing area. If the oven is being installed into a fully enclosed built-under oven housing unit it may be necessary to cut a small slot in the top of the plinth fitted under the unit. Cut a section 400mm wide and a minimum of 15mm high to allow air to pass under the unit. Alternatively cut a section 400 x 450mm in the base of the carcass as indicated.

Failure to allow adequate ventilation to the appliance may result in overheating or damage to adjacent units and could invalidate the warranty.

This appliance is type X installation.

The walls of the kitchen units must be able to withstand temperatures of 75C above ambient (typically this is between 90C and 100C).

When correctly installed ensure that there is a gap of 4mm minimum between the sides of the oven and adjacent furniture doors.

Lift the oven carefully into position on the shelf, taking care NOT to lift it by the door handle. If you lower the oven door, you will see 4 screw holes, 2 on each side of the oven. The oven should then be secured to the housing by fitting screws into these holes. Remember the housing should not be free standing but be secured to the wall and/or adjacent fittings.

How to install your oven

You will need the following housing area fit your oven correctly.

Dimensions	Oven	Housing
Height (mm)	595	600
Width (mm)	595	560
Depth (mm)	563.5	560 (min)

The oven is designed to fit into a cabinet of 600mm width. The oven can be built in or built under the kitchen units, but you must ensure that it is properly ventilated. In the diagram the built-in oven is ventilated by means of a space at the top of the kitchen cabinet. There are many other methods of ventilating your oven - consult a qualified engineer for advice.

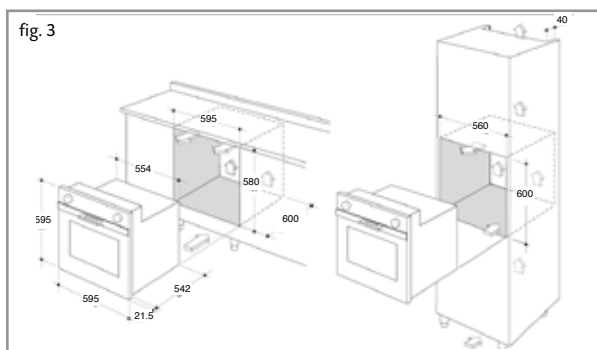

Electricity supply to your oven

Warning! this appliance must be earthed.

This appliance must be connected by a competent person, using fixed wiring via a double pole switched fused spur outlet, protected by a 13A fuse.

We recommend that the appliance is connected by a qualified electrician, who is a member of the N.I.C.E.I.C. and who will comply with the I.E.E and local regulations. The wires in the mains lead are coloured in accordance with the following code:

GREEN AND YELLOW = EARTH BLUE = NEUTRAL BROWN = LIVE.

As the colours of the wires in the mains lead for the appliance, may not correspond with the coloured markings identifying the terminals in your spur box, proceed as follows:

1. The wire which is coloured green and yellow must be connected to the terminal marked E (Earth) or coloured Green.
2. The wire which is coloured blue must be connected to the terminal marked N (Neutral), or coloured Black.
3. The wire which is coloured brown must be connected to the terminal marked L (Live), or coloured Red.

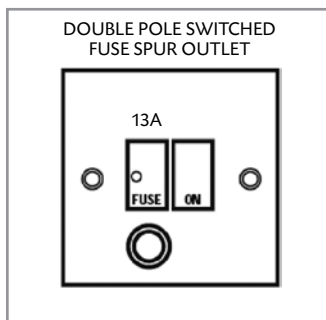



Serviced by



To contact our Customer Care Department, or for Service,
please contact us on the details below.