

FFFL xxxx x
FFFL xxx x
FFxxxxxx
FFUL xxxx x
FUFL xxxx x
EXFL xxxx x
STFxxxxx

GB English

Operating Instructions

REFRIGERATOR/FREEZER COMBINATION

Contents

Operating Instructions, 1
Assistance, 2
Description of the appliance, 3
Description of the appliance, 4
Reversible doors, 5
Installation, 6
Start-up and use, 6
Maintenance and care, 7
Precautions and tips, 8
Troubleshooting, 8

**Register your
appliance now on
08448 24 24 24**

GB

Assistance

Guarantee

12 months Parts and Labour Guarantee

Your appliance has the benefit of our manufacturer's guarantee, which covers the cost of breakdown repairs for twelve months from the date of purchase.

This gives you the reassurance that if, within that time, your appliance is proven to be defective because of either workmanship or materials, we will, at our discretion, either repair or replace the appliance at no cost to you.

This guarantee is subject to the following conditions:

- The appliance has been installed and operated correctly and in accordance with our operating and maintenance instructions.
- The appliance is used only on the electricity or gas supply printed on the rating plate.
- The appliance has been used for normal domestic purposes only.
- The appliance has not been altered, serviced, maintained, dismantled, or otherwise interfered with by any person not authorised by us.
- Any repair work must be undertaken by us or our appointed agent.
- Any parts removed during repair work or any appliance that is replaced become our property.
- The appliance is used in the United Kingdom or Republic of Ireland.

The guarantee does not cover:

- Damage resulting from transportation, improper use, neglect or interference or as a result of improper installation.
- Replacement of any consumable item or accessory. These included but not limited to: plugs, cables, batteries, light bulbs, fluorescent tubes and starters, covers and filters.
- Replacement of any removable parts made of glass or plastic.

THIS GUARANTEE WILL NOT APPLY IF THE APPLIANCE HAS BEEN USED IN COMMERCIAL OR NON-DOMESTIC PREMISES.

5 Year Parts Guarantee

Hotpoint also offers you a free 5 year parts guarantee. This additional guarantee is conditional on you registering your appliance with us and the parts being fitted by one of our authorised engineers. There will be a charge for our engineer's time. To activate the extra parts warranty on your appliance, simply call our registration line on **08448 242424 (Republic of Ireland 01 230 0233)**.

Extended Guarantees

We offer a selection of protection plans that enable you to fully cover yourself against the expense of repair bills for the life of your policy. To find the ideal plan for you please call our advice line on **08448 226 226 (Republic of Ireland 01 230 0233)**.

Helpdesk Service

We have a dedicated team who can provide free advice and assistance with your appliance if you experience any technical difficulties within the first 90 days of ownership. Simply call our Hotpoint Service Hotline on **08448 224 224 (Republic of Ireland 0818 313 413)** for telephone assistance, or, where necessary, to arrange for an engineer to call.

After Sales Service

We pride ourselves on ensuring that you and your Hotpoint appliance receive the very highest level of service. No one understands Hotpoint appliances like we do, so for service from the people that know your appliance best, simply call 08448 224 224.

Our operators are on hand to answer your call every day including weekends and bank holidays.

Our team of 1000 technicians are the largest white goods service organisation in the UK and Ireland available to provide fast, reliable and local service. They have all undergone extensive training at our Training Centre of Excellence and are equipped with the latest diagnostic tools to deliver expert servicing of your Hotpoint appliance.

UK: 08448 224 224

Republic of Ireland: 0818 313 413

or visit

www.hotpointservice.co.uk

Model number: _____

Serial number: _____

Parts and Accessories

We supply a full range of genuine replacement parts as well as accessory products that protect and hygienically clean your appliance to keep it looking good and functioning efficiently throughout its life.

UK: 08448 225 225

Republic of Ireland: 0818 313 413

or visit

www.hotpointservice.co.uk

Appliance Registration

We want to give you additional benefits of Hotpoint ownership. To activate your free 5 year parts guarantee you must register your appliance.

By registering your appliance with us not only do you activate the guarantee all your information will be logged onto our repair system. In the unfortunate event that you need assistance we will have your appliance details to hand when you call us.

UK: 08448 24 24 24

Republic of Ireland: 01 230 0800

or visit

www.hotpointservice.co.uk

Indesit Company UK Ltd. Morley Way, Peterborough, PE2 9JB
Indesit Ireland Ltd. The Crescent Building, Northwood Park, Santry, Dublin 9.

Recycling and Disposal Information

As part of Hotpoint's continued commitment to helping the environment, Hotpoint reserves the right to use quality, recycled components to keep down customer costs and minimise material wastage.

Please dispose of packaging and old appliances carefully. To minimise the risk of injury to children, remove the door, plug, and cut the mains cable off flush with the appliance. Dispose of these parts separately to ensure that the appliance can no longer be plugged into mains socket, and the door cannot be locked shut.

GB - model

GB - serial number





Mod. RG 2330		TI	Cod. 93139180000		S/N 704211801	
240 V	Hz	150 W	W	Fuse	A	Max 15
Total	340	75			Freez.	Capac
Gross Bruto		Gross Bruto		Net Util		Classe
Brut		Brut		Brut	Poder de Cong	Classe N
					kg/24 h	4,0
Compr. Syst.	R 134 a	Test Pressure	HG-235			
	kg 0,090	P.S.-L.	LOW 140			
Made in Italy		13918				

PLEASE PHONE US TO REGISTER YOUR APPLIANCE AND ACTIVATE YOUR 5 YEAR PARTS GUARANTEE ON 08448 24 24 24

GB

Description of the appliance

Control panel

- 1 **REFRIGERATOR OPERATION** Knob to regulate the temperature of the refrigerator compartment.
 is the optimal temperature for energy saving levels.
 is the holiday function (see Maintenance and care).
OFF switches the refrigerator off.
 - 2 **SUPER COOL** (quick cool) to lower the temperature of the refrigerator compartment rapidly. When it is pressed, the **SUPER COOL** indicator light illuminates (see Start-up and use).
 - 3 **SUPER COOL** Yellow indicator light (rapid cooling) illuminates when the **SUPER COOL** button is pressed.
 - 4 **POWER** Indicator light illuminates when the appliance is connected to the electricity network.
 - 5 **SUPER FREEZE** button (rapid freezing) to freeze fresh food. When it is pressed, the **SUPER FREEZE** indicator light illuminates (see Start-up and use).
 - 6 **SUPER FREEZE** Yellow indicator light (rapid freezing) illuminates when the **SUPER FREEZE** button is pressed.
 - 7 **FREEZER OPERATION** Knob to regulate the temperature of the freezer compartment.
 is the optimal temperature for energy saving levels.
 **OFF** switches the appliance off, including the refrigerator.
- ! The indicator lights are also used to indicate an unusual temperature increase in the freezer compartment (see Troubleshooting).

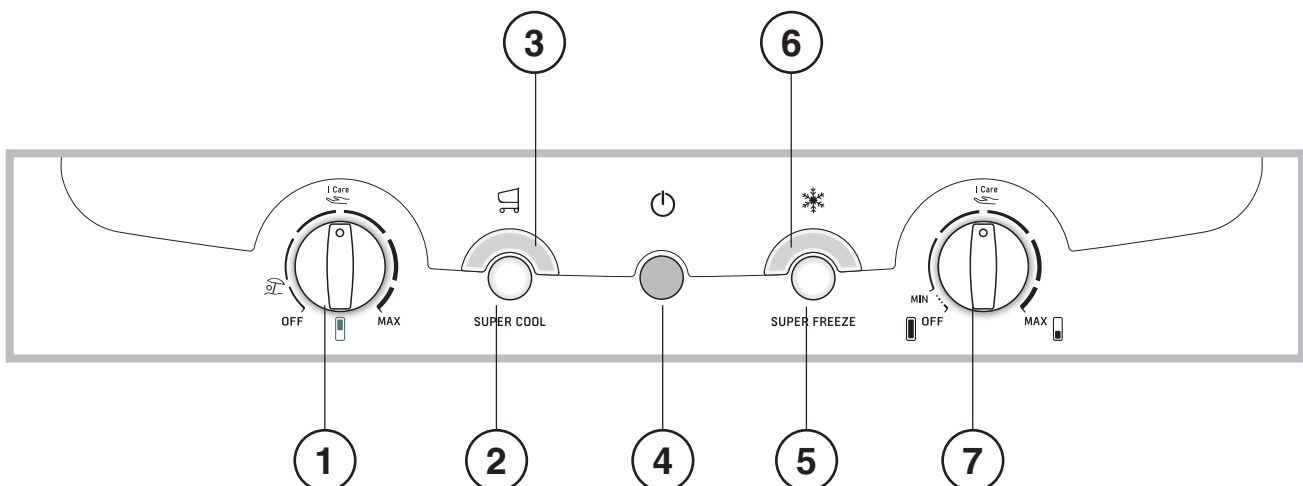

Description of the appliance

Overall view

The instructions contained in this manual are applicable to different model refrigerators. The diagrams may not directly represent the appliance purchased. For more complex features, consult the following pages.

- 1 Levelling **FEET**
- 2 **STORAGE** compartment
- 3 **FREEZER** and **STORAGE** compartment
- 4 **FRUIT** and **VEGETABLE** bin *
- 5 **FOOD CARE ZONE** for **MEAT** and **CHEESE** *
- 6 **WINE RACK** *
- 7 **SHELVES** *
- 8 **LAMP** (see Maintenance).
- 9 Removable multipurpose **SHELVES** *
- 10 **BOTTLE** shelf

* Varies by number and/or position, available only on certain models.

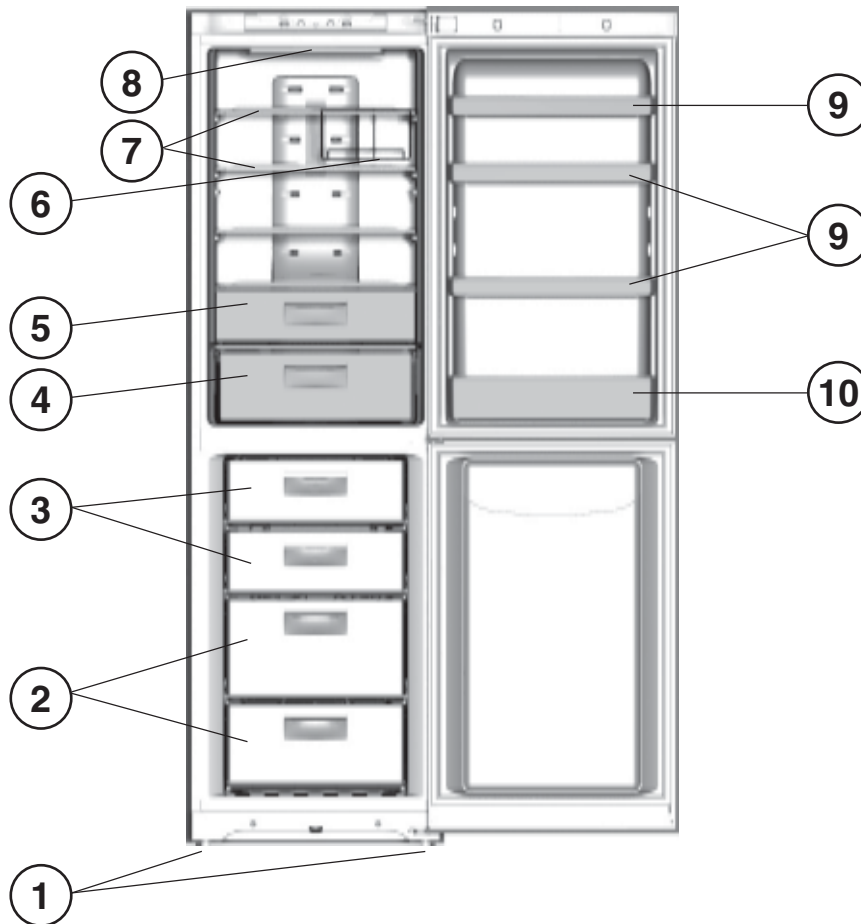

GB

Reversible doors

* Available only on certain models.

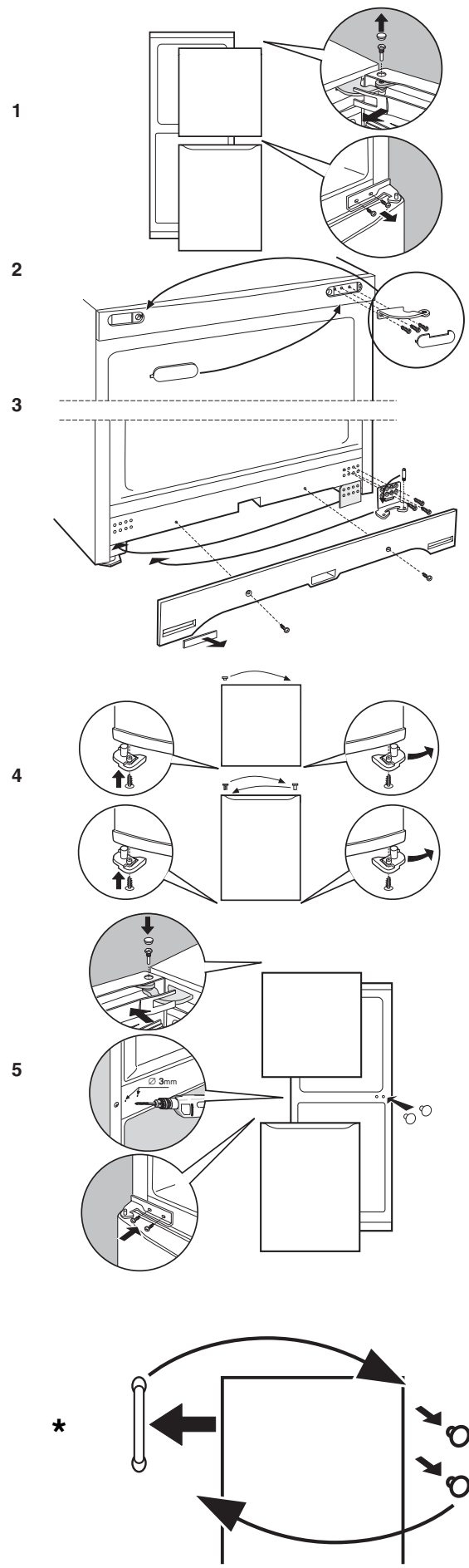

Installation

! Before placing your new appliance into operation please read these operating instructions carefully. They contain important information for safe use, for installation and for care of the appliance. ! Please keep these operating instructions for future reference. Pass them on to possible new owners of the appliance.

Positioning and connection

Positioning

1. Place the appliance in a well-ventilated humidity-free room.
2. Do not obstruct the rear fan grills. The compressor and condenser give off heat and require good ventilation to operate correctly and save energy.
3. Leave a space of at least 10 cm between the top part of the appliance and any furniture above it, and at least 5 cm between the sides and any furniture/side walls.
4. Ensure the appliance is away from any sources of heat (direct sunlight, electric stove, etc.).
5. In order to maintain the correct distance between the appliance and the wall behind it, fit the spacers supplied in the installation kit, following the instructions provided.

Levelling

1. Install the appliance on a level and rigid floor.
2. If the floor is not perfectly horizontal, adjust the refrigerator by tightening or loosening the front feet.

Electrical connections

After the appliance has been transported, carefully place it vertically and wait at least 3 hours before connecting it to the electricity mains. Before inserting the plug into the electrical socket ensure the following:

- The appliance is earthed and the plug is compliant with the law.
- The socket can withstand the maximum power of the appliance, which is indicated on the data plate located on the bottom left side of the fridge (e.g. 150 W).
- The voltage must be in the range between the values indicated on the data plate located on the bottom left side (e.g. 220-240V).
- The socket is compatible with the plug of the appliance. If the socket is incompatible with the plug, ask an authorised technician to replace it (*see Assistance*). Do not use extension cords or multiple sockets.

! Once the appliance has been installed, the power supply cable and the electrical socket must be easily accessible.

! The cable must not be bent or compressed.

! The cable must be checked regularly and replaced by authorised technicians only (*see Assistance*).

! **The manufacturer declines any liability should these safety measures not be observed.**

Your appliance is supplied with a 13amp fused plug that can be plugged into a 13amp socket for immediate use. Before using the appliance please read the instructions below.

WARNING:

THIS APPLIANCE MUST BE EARTHED.

Replacing fuse covers:

When replacing a faulty fuse, a 13amp ASTA approved fuse to BS 1362 should always be used and the fuse cover re-fitted.

If the fuse cover is lost, the plug must not be used until a replacement is obtained.

Replacement fuse covers:

If a replacement fuse cover is fitted, it must be of the correct colour as indicated by the coloured marking or the colour that is embossed in words on the base of the plug.

PLEASE PHONE US TO REGISTER YOUR APPLIANCE AND ACTIVATE YOUR 5 YEAR PARTS GUARANTEE ON 08448 24 24 24

Changing the plug:

Removing the plug

If your appliance has a non-rewireable moulded plug and you should wish to remove it to add a longer cable or to re-route the mains cable through partitions, units etc. please ensure that either:

- The plug is replaced by a fused 13amp re-wireable plug bearing the BSI mark of approval.

or

- The mains cable is wired directly into a 13amp cable outlet, controlled by a switch (in compliance with BS 5733) which is accessible without moving the appliance.

Disposing of the plug

Cut off and dispose of the supplied plug if it does not fit your socket. The cable should be cut as close as possible to the moulded plug.

Remove the fuse.

WARNING:

To avoid a shock hazard do not insert the discarded plug into a socket anywhere else.

Fitting a new plug

IMPORTANT:

WIRES IN THE MAINS LEAD ARE COLOURED IN ACCORDANCE WITH THE FOLLOWING CODE...

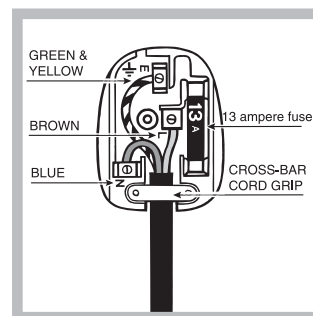

Green and Yellow	- Earth
Blue	- Neutral
Brown	- Live

As the colours of the wires in the mains lead may not correspond with the coloured markings identifying the terminals in your plug, proceed as follows:

- Connect **Green and Yellow** wire to terminal marked 'E' or  or coloured Green and Yellow.
- Connect **Brown** wire to terminal marked 'L' or coloured red or brown.
- Connect **Blue** wire to terminal marked 'N' or coloured Black or Blue.

If a 13amp plug (BS 1363) is used it must be fitted with a 13amp fuse.

If you are in any doubt about the electrical supply to your machine, consult a qualified electrician before use.

CE Marking certifies that this appliance conforms to the following EEC directives:

**Low Voltage Equipment - 73/23/EEC & 93/68 EEC
Electromagnetic Compatibility 89/336/EEC, 92/31/EEC & 93/68/EEC**

Start-up and use

Starting the appliance

! Before starting the appliance, follow the installation instructions (see *Installation*).

! Before connecting the appliance, clean the compartments and accessories well with lukewarm water and bicarbonate.

! The appliance comes with a motor protection control system which makes the compressor start approximately 8 minutes after being switched on. The compressor also starts each time the power supply is cut off whether voluntarily or involuntarily (blackout).

1. Set the FREEZER OPERATION knob on  OFF.
2. Insert the plug into the socket and ensure that the green POWER indicator light illuminates.
3. Turn the REFRIGERATOR OPERATION knob to an average value. After a few hours you will be able to put food in the refrigerator.
4. Turn the FREEZER OPERATION knob to an average value and press the SUPER FREEZE button (rapid freezing): the SUPER FREEZE indicator light will illuminate. Once the refrigerator has reached the optimal temperature, the indicator light goes out and you can begin food storage.

Chiller system

No Frost



The No Frost system circulates cold air continuously to collect humidity and prevent ice and frost formation. The system maintains an optimal humidity level in the compartment, preserving the original quality of the food, preventing the food from sticking together and making defrosting a thing of the past. Do not block the aeration cells by placing food or containers in direct contact with the refrigerating back panel. Close bottles and wrap food tightly.

Using the refrigerator to its full potential

- Place only cold or lukewarm foods in the compartment, never hot foods (see Precautions and tips).
- Remember that cooked foods do not last longer than raw foods.
- Do not store liquids in open containers: they will increase the level of humidity in the refrigerator and cause condensation to form.

SHELVES: with or without grill.

Due to the special guides the shelves are removable and the height is adjustable (see diagram), allowing easy storage of large containers and food. Height can be adjusted without complete removal of the shelf.

*Varies by number and/or position, available only on certain models.

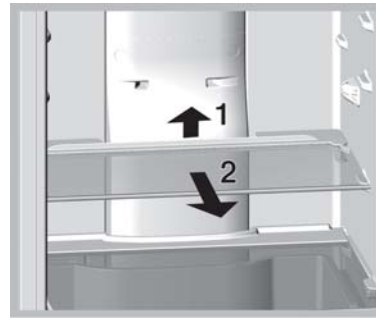

TEMPERATURE Indicator light*: to identify the coldest area in the refrigerator.

1. Check that OK appears clearly on the indicator light (see diagram).



2. If the word "OK" does not appear it means that the temperature is too high: adjust the REFRIGERATOR OPERATION knob to a higher position (colder) and wait approximately 10 hours until the temperature has been stabilised.
3. Check the indicator light again: if necessary, readjust it following the initial process. If large quantities of food have been added or if the refrigerator door has been opened frequently, it is normal for the indicator not to show OK. Wait at least 10 hours before adjusting the REFRIGERATOR OPERATION knob to a higher setting.

Food Care Zone *

Area dedicated to the storage of fresh food, such as meat and fish. Thanks to the low temperature inside the compartment, the Food Care Zone extends the period of time for which the food can be stored, keeping it fresh for up to a week.

Dual led *

Thanks to the powerful light it emits, the new dual LED lighting system offers a clear view of all foods, with no shadowy areas.

If the LEDs need to be replaced, please contact the Technical Assistance Service.

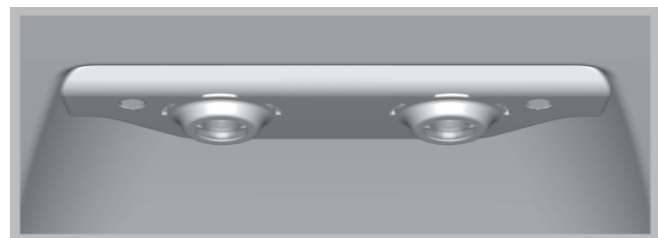

Using the freezer to its full potential

- Use the FREEZER OPERATION knob to adjust the temperature (see *Description*).
- Do not re-freeze food that is defrosting or that has already been defrosted. These foods must be cooked and eaten (within 24 hours).
- Fresh food that needs to be frozen must not come into contact with food that has already been defrosted. Fresh food must be stored in the top FREEZER and STORAGE compartment where the temperature drops below -18°C and guarantees rapid freezing.
- To freeze fresh food in the best and safest way possible, activate the SUPER FREEZE function 24 hours before placing the food in the freezer. After placing the food inside, activate the SUPER FREEZE function again; it will be deactivated automatically after 24 hours;

- Do not place glass bottles which contain liquids, and which are corked or hermetically sealed in the freezer because they could break.
- The maximum quantity of food that may be frozen daily is indicated on the plate containing the technical properties located on the bottom left side of the refrigerator compartment (for example: Kg/24h: 4).

! To avoid blocking the air circulation inside the freezer compartment, it is advisable not to obstruct the ventilation holes with food or containers.

! Do not open the door during freezing.

! If there is a power cut or malfunction, do not open the freezer door. This will help maintain the temperature inside the freezer, ensuring that foods are conserved for at least 9 -14 hours.

Easy Ice *

The double tub was designed to optimise space in the freezer compartment and to ensure that ice is always readily available. The trays can be stacked or filled and used separately. Furthermore, the special fastening system makes Easy Ice an extremely flexible solution, as it can be positioned in the right or left part of the top drawers.



Maintenance and care

Switching the appliance off

During cleaning and maintenance it is necessary to disconnect the appliance from the electricity supply:

1. set the FREEZER OPERATION knob on  OFF
2. pull the plug out of the socket

Cleaning the appliance

- We recommend you clean your fridge with our Professional Fridge cleaner. To order please call us on 08448 225 225 or visit www.hotpointservice.co.uk
- The external and internal parts, as well as the rubber seals may be cleaned using a sponge that has been soaked in lukewarm water and bicarbonate of soda or neutral soap. Do not use solvents, abrasive products, bleach or ammonia.
- The removable accessories may be soaked in warm water and soap or dishwashing liquid. Rinse and dry them carefully.
- The back of the appliance may collect dust which can be removed by delicately using the hose of a vacuum cleaner set on medium power. The appliance must be switched off and the plug must be pulled out before cleaning the appliance.

*Varies by number and/or position, available only on certain models.

Avoiding mould and unpleasant odours

- The appliance is manufactured with hygienic materials which are odour free. In order to maintain an odour free refrigerator and to prevent the formation of stains, food must always be covered or sealed properly.
- If you want to switch the appliance off for an extended period of time, clean the inside and leave the doors open.

Holiday function

To minimise energy usage when on holiday, it is not necessary to switch the appliance off. The appliance has a function which allows it to maintain the temperature of the refrigerator compartment at approximately 12°C (which can also be used to conserve make-up and beauty products). The freezer temperature must be set to the minimum value in order to preserve the food.

To enable the function:

set the REFRIGERATOR OPERATION knob on .

A double acoustic signal informs you when it has been enabled. A single acoustic signal informs you when it has been disabled.

Replacing the light bulb *

- To order a replacement bulb please call us on 08448 225 225 or visit www.hotpointservice.co.uk

To replace the light bulb in the refrigerator compartment, pull out the plug from the electrical socket. Follow the instructions below. Access the light bulb by removing the cover as indicated in the diagram. Replace it with a similar light bulb within the power range indicated on the cover.

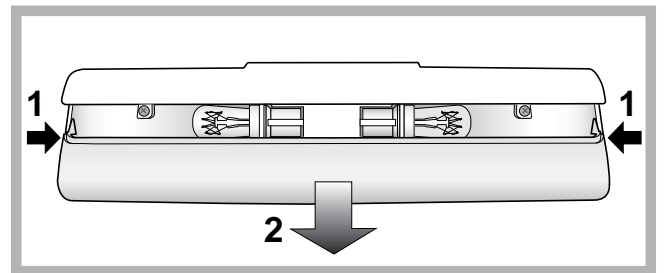

Precautions and tips

! The appliance was designed and manufactured in compliance with international safety standards. The following warnings are provided for safety reasons and must be read carefully.



This appliance complies with the following Community Directives:
 - 73/23/EEC of 19/02/73 (Low Voltage) and subsequent amendments;
 - 89/336/EEC of 03.05.89 (Electromagnetic Compatibility) and subsequent amendments;
 - 2002/96/CE.

General safety

- The appliance was designed for domestic use inside the home and is not intended for commercial or industrial use.
- The appliance must be used to store and freeze food products by adults only and according to the instructions in this manual.
- The appliance must not be installed outdoors, even in covered areas. It is extremely dangerous to leave the appliance exposed to rain and storms.
- Do not touch the appliance with bare feet or with wet or moist hands and feet.
- Do not touch the internal cooling elements: this could cause skin abrasions or frost/freezer burns.

- When unplugging the appliance always pull the plug from the mains socket, do not pull on the cable.
- Before cleaning and maintenance, always switch off the appliance and disconnect it from the electrical supply. It is not sufficient to set the TEMPERATURE ADJUSTMENT knobs on **OFF** (appliance off) to eliminate all electrical contact.
- In the case of a malfunction, under no circumstances should you attempt to repair the appliance yourself. Repairs carried out by inexperienced persons may cause injury or further malfunctioning of the appliance.
- Do not use any sharp or pointed utensils or electrical equipment - other than the type recommended by the manufacturer - inside the frozen food storage compartments.
- Do not put ice cubes taken directly from the freezer into your mouth.
- This appliance is not intended for use by persons (including children) with reduced physical, sensory or lack of experience and knowledge unless they have been given supervision or instruction concerning use of the appliance by a person responsible for their safety. Children should be supervised to ensure that they do not play with the appliance.
- Keep packaging material out of the reach of children! It can become a choking or suffocation hazard.

Disposal

- Observe local environmental standards when disposing packaging material for recycling purposes.
- The European Directive 2002/96/EC on Waste Electrical and Electronic Equipment (WEEE), requires that old household electrical appliances must not be disposed of in the normal unsorted municipal waste stream. Old appliances must be collected separately in order to optimise the recovery and recycling of the materials they contain and reduce the impact on human health and the environment. The crossed out "wheeled bin" symbol on the product reminds you of your obligation, that when you dispose of the appliance it must be separately collected. Consumers should contact their local authority or retailer for information concerning the correct disposal of their old appliance.

Respecting and conserving the environment

- Install the appliance in a fresh and well-ventilated room. Ensure that it is protected from direct sunlight and do not place it near heat sources.
- Try to avoid keeping the door open for long periods or opening the door too frequently in order to conserve energy.
- Do not fill the appliance with too much food: cold air must circulate freely for food to be preserved properly. If circulation is impeded, the compressor will work continuously.
- Do not place hot food directly into the refrigerator. The internal temperature will increase and force the compressor to work harder and will consume more energy.
- Defrost the appliance if ice forms (*see Maintenance*). A thick layer of ice makes cold transference to food products more difficult and results in increased energy consumption.

Troubleshooting

If the appliance does not work, before calling for Assistance (see Assistance), check for a solution from the following list.

The green POWER indicator light does not illuminate.

- The plug has not been inserted into the electrical socket, or not far enough to make contact, or there is no power in the house.

The motor does not start.

- The appliance comes with a motor protection control (*see Start-up and use*).

The indicator lights are on but the light is dim.

- Pull out and reverse the plug before putting it back in the socket.

a) The alarm sounds.

- The refrigerator door has remained open for more than two minutes (the buzzer will stop sounding when you shut the door) or the correct switching-off procedure was not followed (*see Maintenance*).

b) The alarm sounds and the two yellow indicator lights flash.

- The temperature in the freezer is too high. Check the quality of the food products and dispose if necessary.

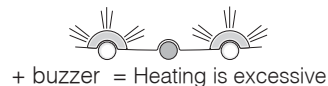

c) The alarm sounds and the two yellow indicator lights as well as the green one flash.

- The temperature in the freezer has reached a dangerous level. The food must be disposed immediately.

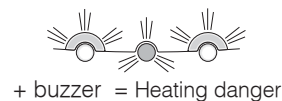

b/c) In both these cases the freezer will maintain a temperature of about 0°C so that the food does not re-freeze.

To turn off the acoustic signal open and close the refrigerator door. To restore normal operation bring the FREEZER OPERATION knob setting to OFF (off) and turn the appliance on again.

The green POWER indicator light flashes.

- The appliance is not operating correctly. Contact the Technical Assistance Centre.

The refrigerator and the freezer do not cool well.

- The doors do not close properly or the seals are damaged.
- The doors are opened too frequently.
- The OPERATION knobs are not on the correct setting (*see Description*).
- The refrigerator or the freezer have been over-filled.

The food inside the refrigerator is beginning to freeze.

- The REFRIGERATOR OPERATION knob is not on the correct setting (*see Description*).
- The food is in contact with the back inside wall of the refrigerator.

The motor runs continuously.

- The SUPER FREEZE button has been pressed (rapid freezing); the yellow SUPER FREEZE light is on or flashing (*see Description*).
- The door is not closed properly or is continuously opened.
- The outside ambient temperature is very high.

The appliance makes a lot of noise.

- The appliance has not been installed on a level surface (see *Installation*).
- The appliance has been installed between cabinets that vibrate and make noise.
- The internal refrigerant makes a slight noise even when the compressor is off. This is not a defect, it is normal.

Don't forget should our advice fail to resolve the problem with your appliance please call us on 08448 224 224 to arrange an engineer visit. Or visit www.hotpointservice.co.uk

Product failures are fully covered by your 12 months parts and labour guarantee. However, if we attend and there is no product failure or the failure has been caused by damage, misuse or by incorrect installation, charges will apply.

